

SONDEN
PROBES
SONDAS
SONDES
SONDE

AL

nopa[®] instruments



SONDEN PROBES SONDAS SONDES SONDE

Sonden
Probes
Sondas
Sondes
Sonde

AA

AB

AC

AD

AE

AF

AK

AL

AM

AO

AP

AR

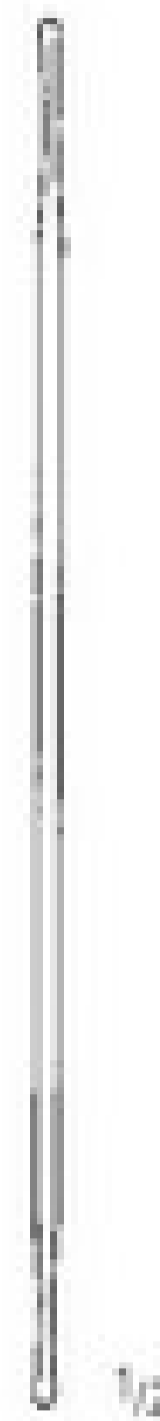

1/2

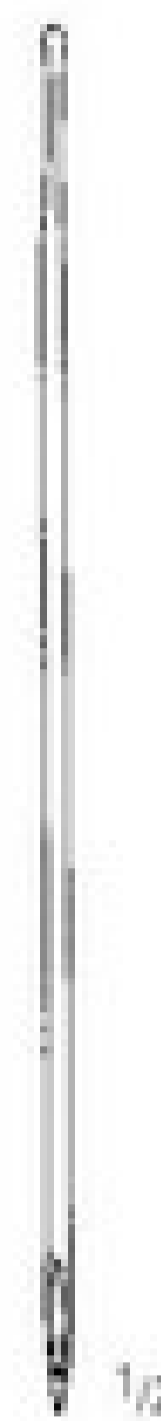

1/2

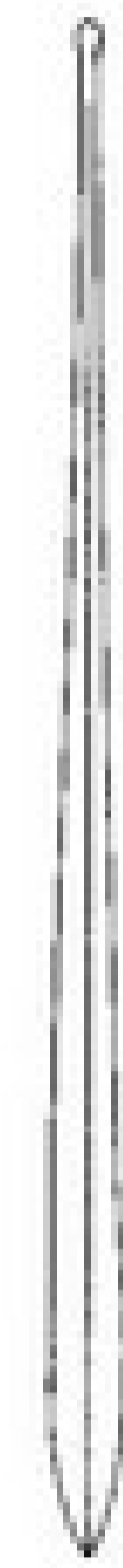

1/2

Silber
silver
de plata
en argent
d'argento

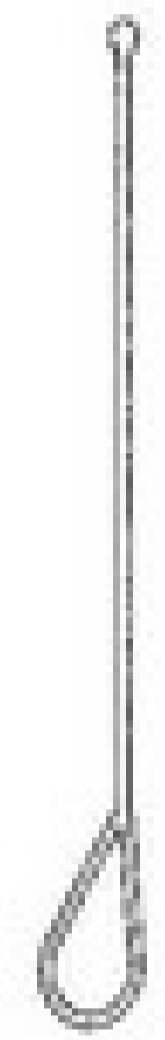

1/2

	1,0 mm	2,0 mm
11,5 cm/4 1/2"	AL 001/11	AL 002/11
13,0 cm/5"	AL 001/13	AL 002/13
14,5 cm/5 3/4"	AL 001/14	AL 002/14
16,0 cm/6 1/4"	AL 001/16	AL 002/16
18,0 cm/7"	AL 001/18	AL 002/18
20,0 cm/8"	AL 001/20	AL 002/20
25,0 cm/10"	AL 001/25	AL 002/25

AL 003/11
AL 003/13
AL 003/14
AL 003/16
AL 003/18
AL 003/20
AL 003/25

MYRTLE LEAF

AL 007/14
AL 007/16
AL 007/18
AL 007/20

STACKE
AL 013/10
10,5 cm/4 1/4"
Ø 1,0 mm

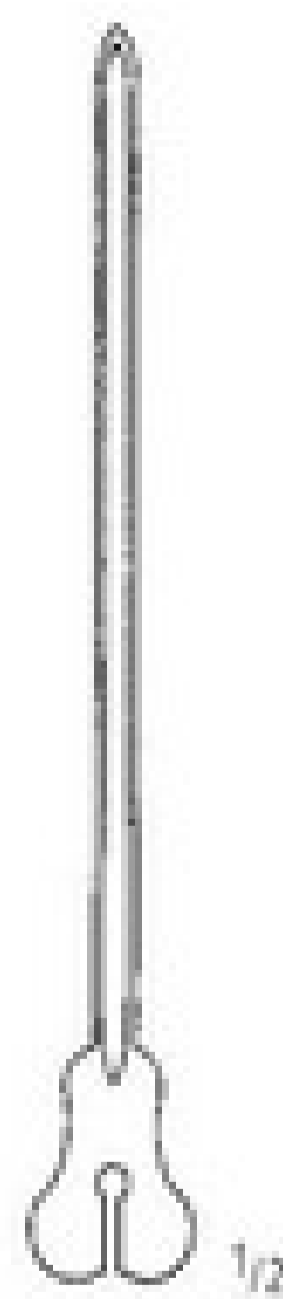

1/2

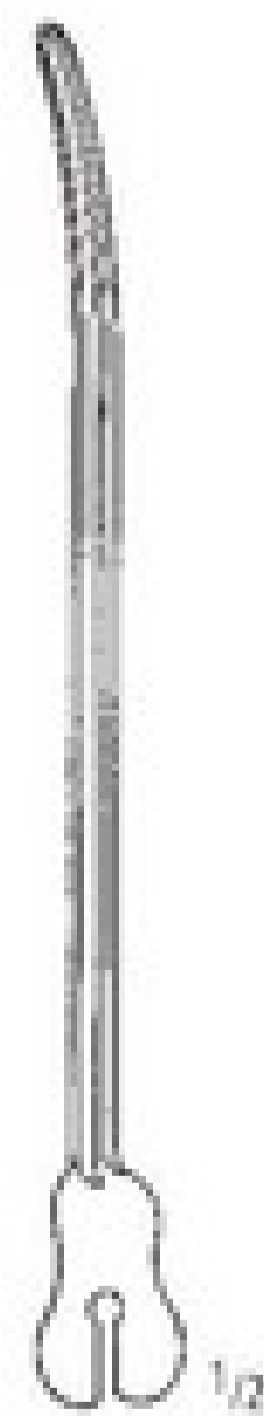

1/2

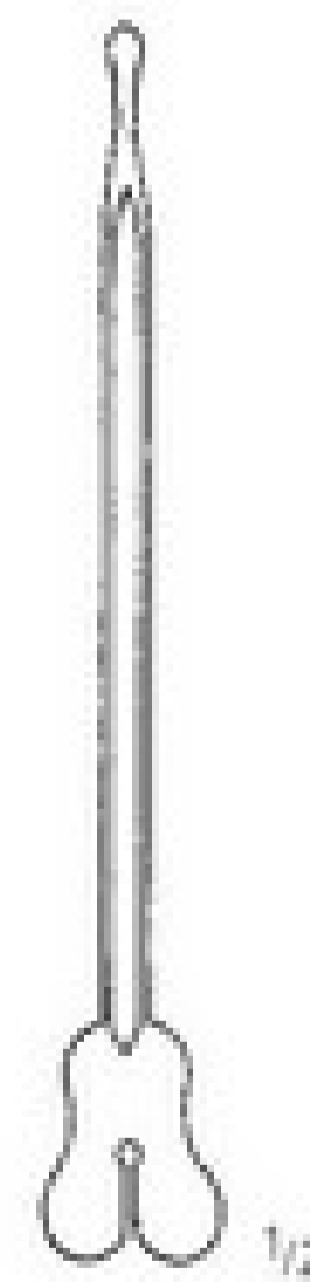

1/2

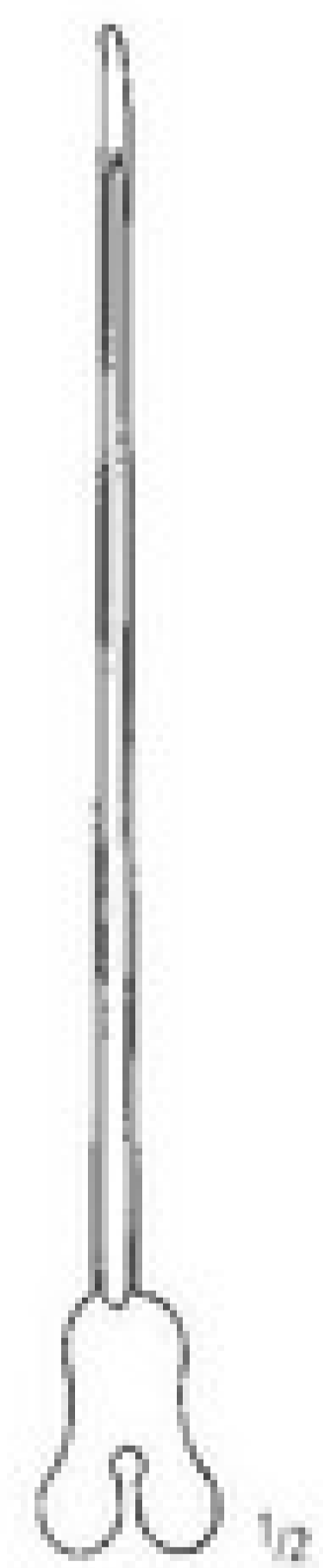

1/2

11,5 cm/4 1/2"	AL 015/11
13,0 cm/5"	AL 015/13
14,5 cm/5 3/4"	AL 015/14
16,0 cm/6 1/4"	AL 015/16
18,0 cm/7"	AL 015/18
20,0 cm/8"	AL 015/20

DOYEN
AL 017/14

AL 020/11
AL 020/13
AL 020/14
AL 020/16
AL 020/18

NELATON
AL 022/16

AL SONDEN PROBES SONDAS SONDES SONDE

Sonden und Watteträger
 Probes and Cotton Applicators
 Sondas y Porta-algodones
 Sondes et Porte-coton
 Sonde e Portacotone

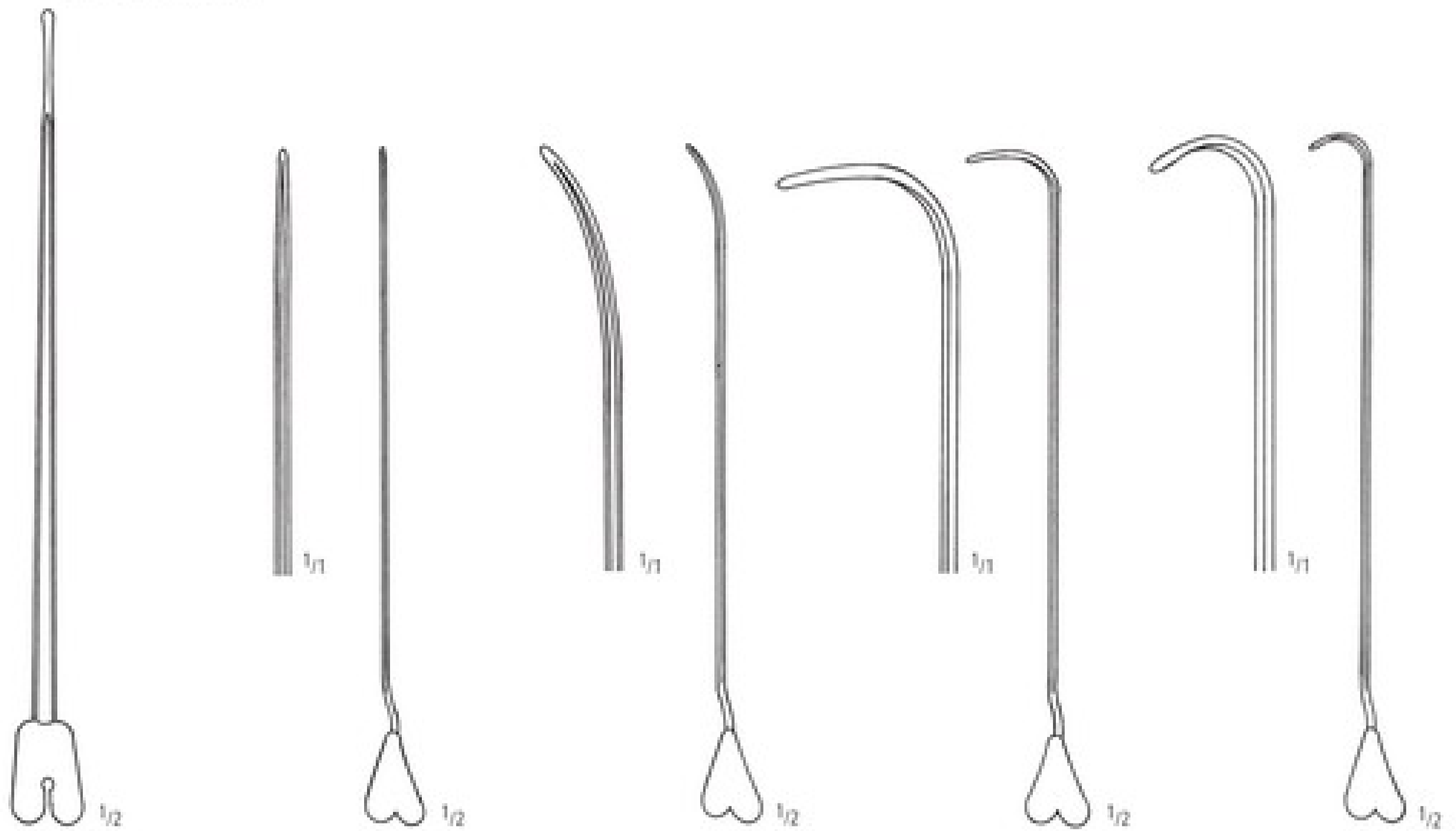

BRODIE

AL 026/20
 20,0 cm/8"

LOCKHART-MUMMRERY

Fig. 1
 AL 030/01

Fig. 2
 AL 030/02

LOCKHART-MUMMRERY

Fig. 3
 AL 030/03

Fig. 4
 AL 030/04

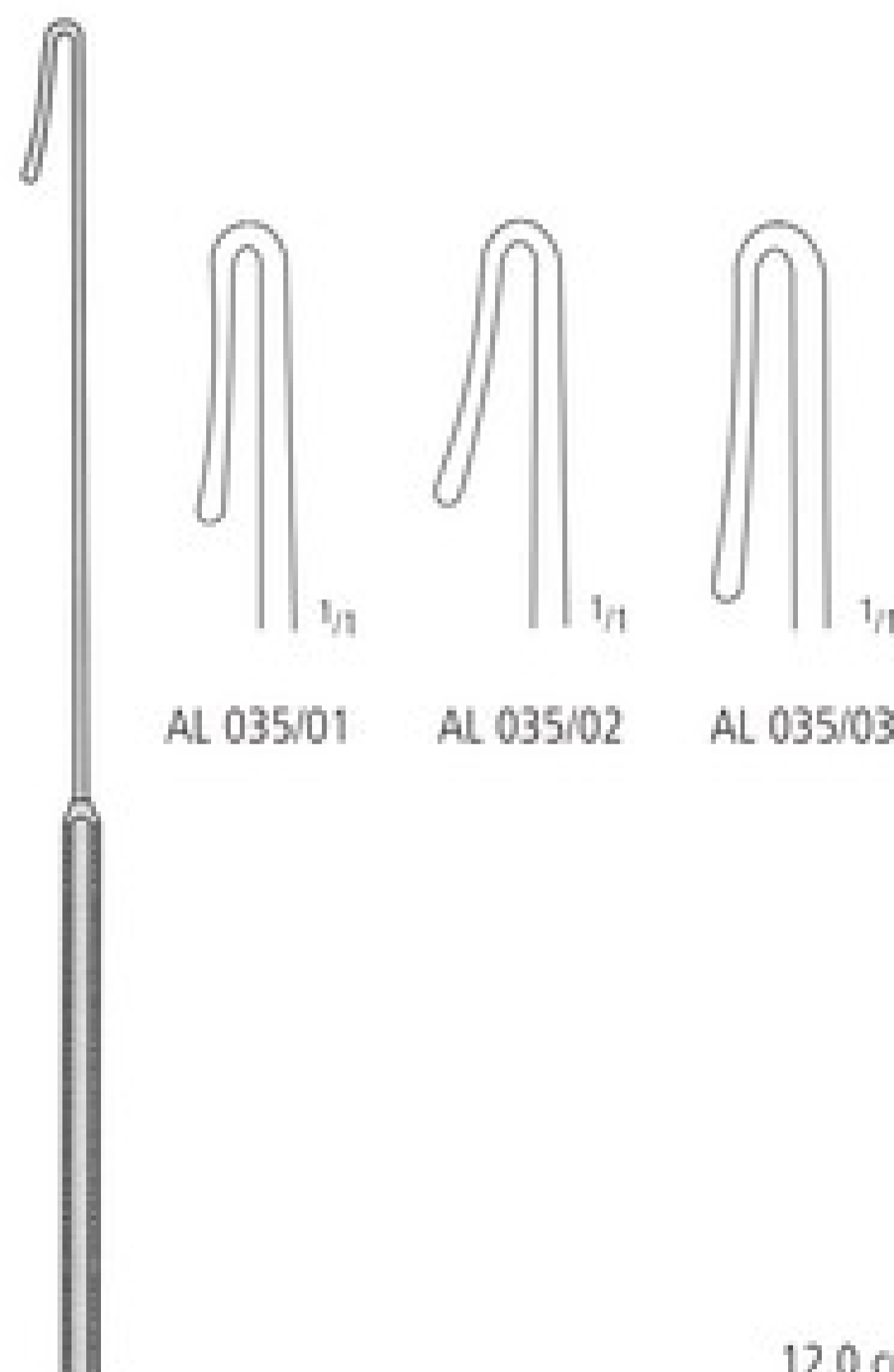

AL 035/01

AL 035/02

AL 035/03

PRATT

21,0 cm/8¹/₄"

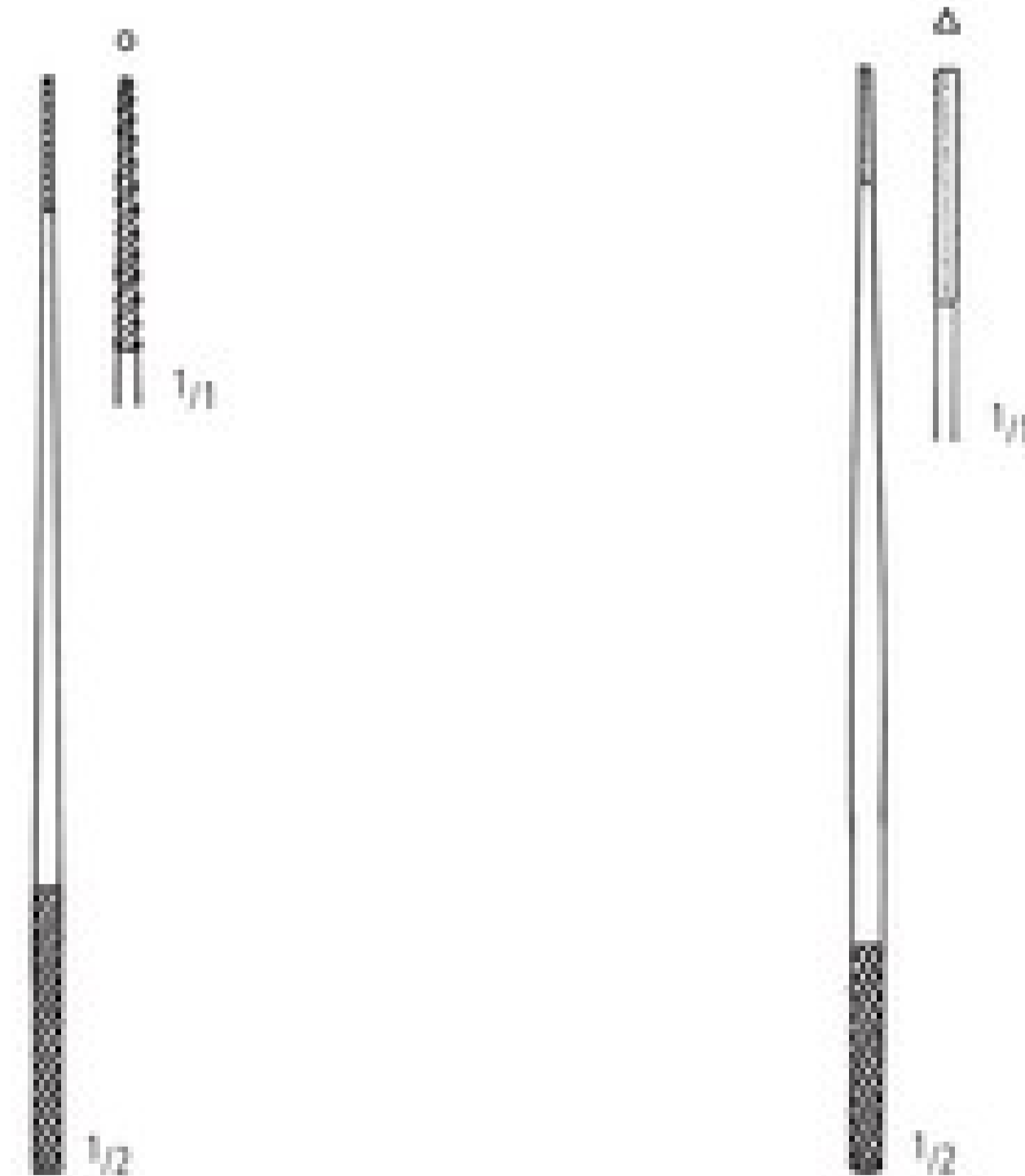

FARREL

0,9 mm 1,1 mm 1,2 mm
 12,0 cm/4³/₄" AL 100/12
 14,0 cm/5¹/₂" AL 100/14
 16,5 cm/6¹/₂" AL 100/16
 18,0 cm/7" AL 100/18

FARREL

0,9 mm 1,1 mm 1,2 mm
 AL 120/12
 AL 120/14
 AL 120/16
 AL 120/18

SONDEN PROBES SONDAS SONDES SONDE

Watteträger und Krampfader-Besteck
 Cotton Applicators and Varicose Vein Probe Set
 Porta-algodones y sonda para várices
 Porte-coton et trousse à varices
 Portacotone e astuccio per varici

AA

AB

AC

AD

AE

AF

AK

AL

AM

AO

AP

AR



UCKERMANN
 AL 160/16
 16,0 cm/6 1/4"



JOBSON-HORNE
 AL 162/18
 18,0 cm/7"

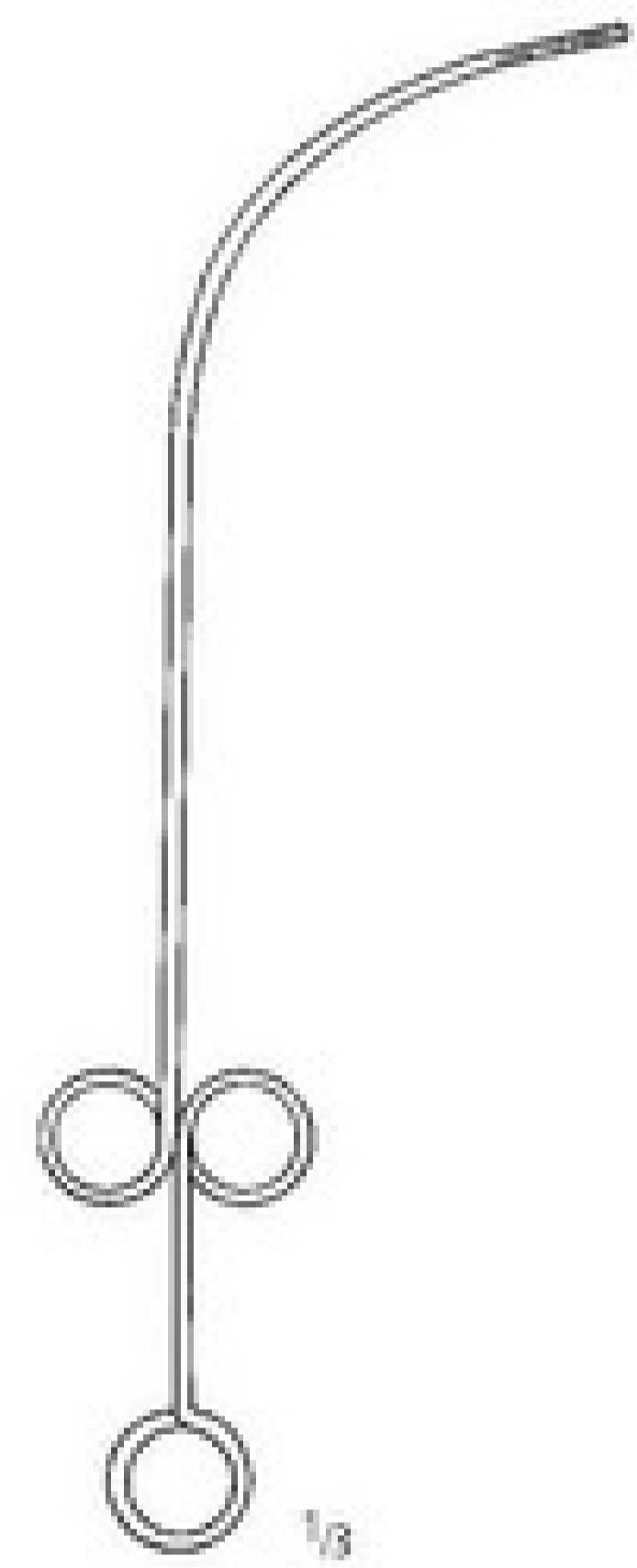

FEIN
 AL 170/28
 28,0 cm/11"



3,0 mm
 AL 182/03

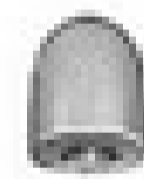

6,0 mm
 AL 182/06

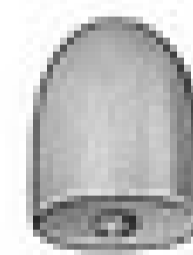

9,0 mm
 AL 182/09

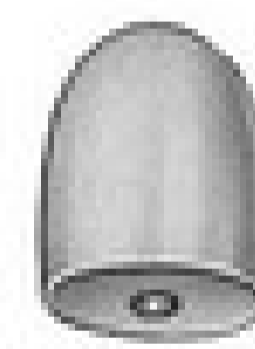

12,0 mm
 AL 182/12

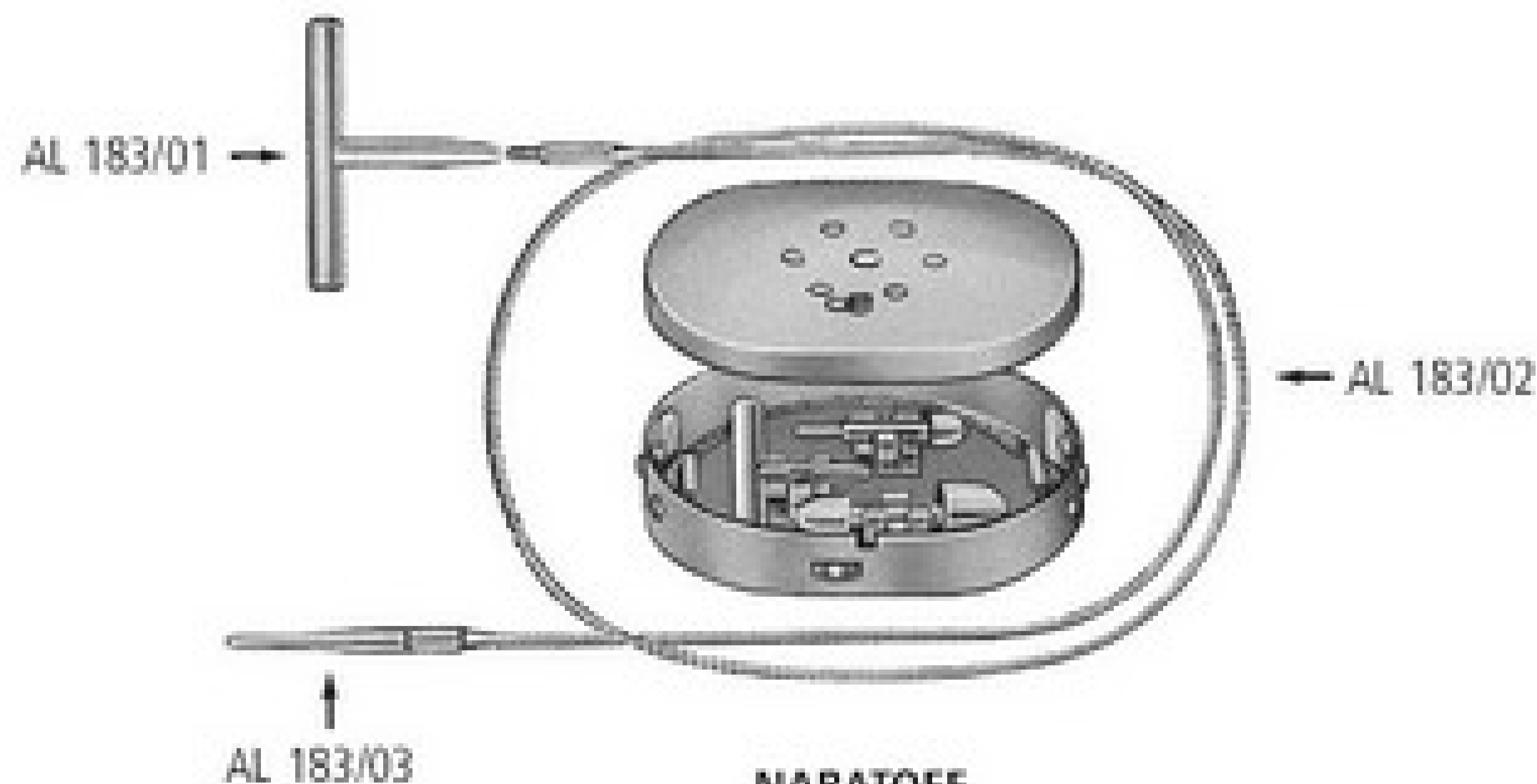

NABATOFF
 AL 180/00

komplett-completo-completo-complet-completo

AL SONDEN PROBES SONDAS SONDES SONDE

Gefäß-Dilatatoren
 Vascular Dilators
 Dilatadores vasculares
 Dilatateurs vasculaires
 Dilatatori per vasi



biegsam
 malleable
 malleables
 malléables
 malleabili

	14,0 cm/5 ¹ / ₂ "	21,0 cm/8 ¹ / ₄ "
1,0 mm	AL 190/10	AL 192/10
1,5 mm	AL 190/15	AL 192/15
2,0 mm	AL 190/20	AL 192/20
2,5 mm	AL 190/25	AL 192/25
3,0 mm	AL 190/30	AL 192/30
3,5 mm	AL 190/35	AL 192/35
4,0 mm	AL 190/40	AL 192/40
4,5 mm	AL 190/45	AL 192/45
5,0 mm	AL 190/50	AL 192/50

GARRETT

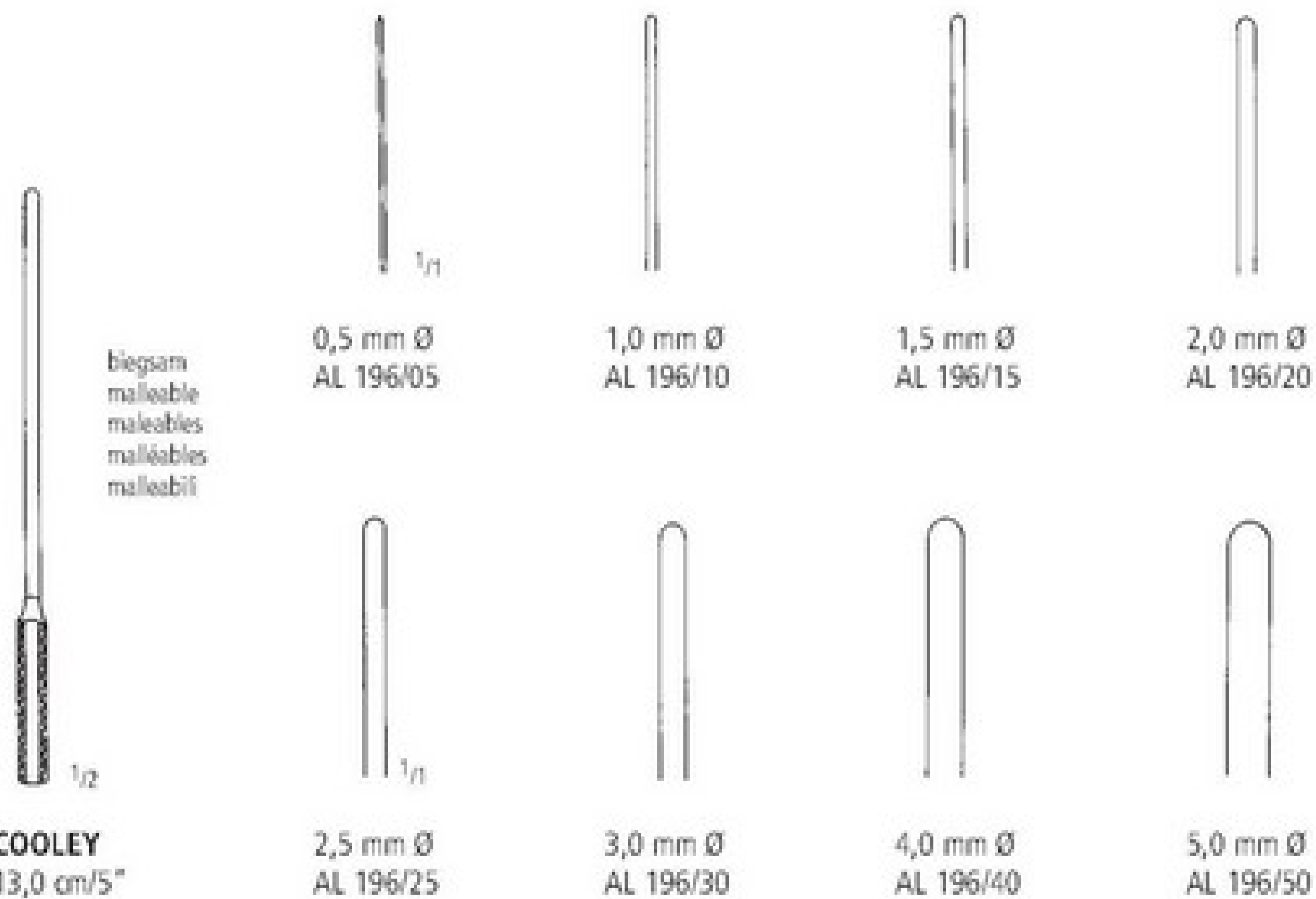

biegsam
 malleable
 malleables
 malléables
 malleabili

0,5 mm Ø
 AL 196/05

1,0 mm Ø
 AL 196/10

1,5 mm Ø
 AL 196/15

2,0 mm Ø
 AL 196/20

2,5 mm Ø
 AL 196/25

3,0 mm Ø
 AL 196/30

4,0 mm Ø
 AL 196/40

5,0 mm Ø
 AL 196/50

COOLEY
 13,0 cm/5"

SONDEN PROBES SONDAS SONDES SONDE

Gefäß-Dilatatoren
 Vascular Dilators
 Dilatadores vasculares
 Dilatateurs vasculaires
 Dilatatori per vasi

AA
AB
AC
AD
AE
AF
AK
AL
AM
AO
AP
AR

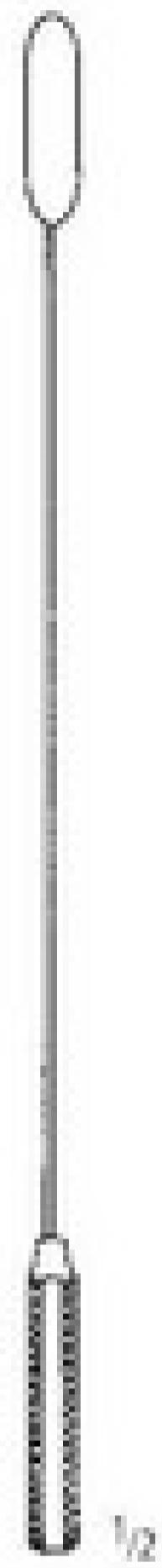

DE BAKEY

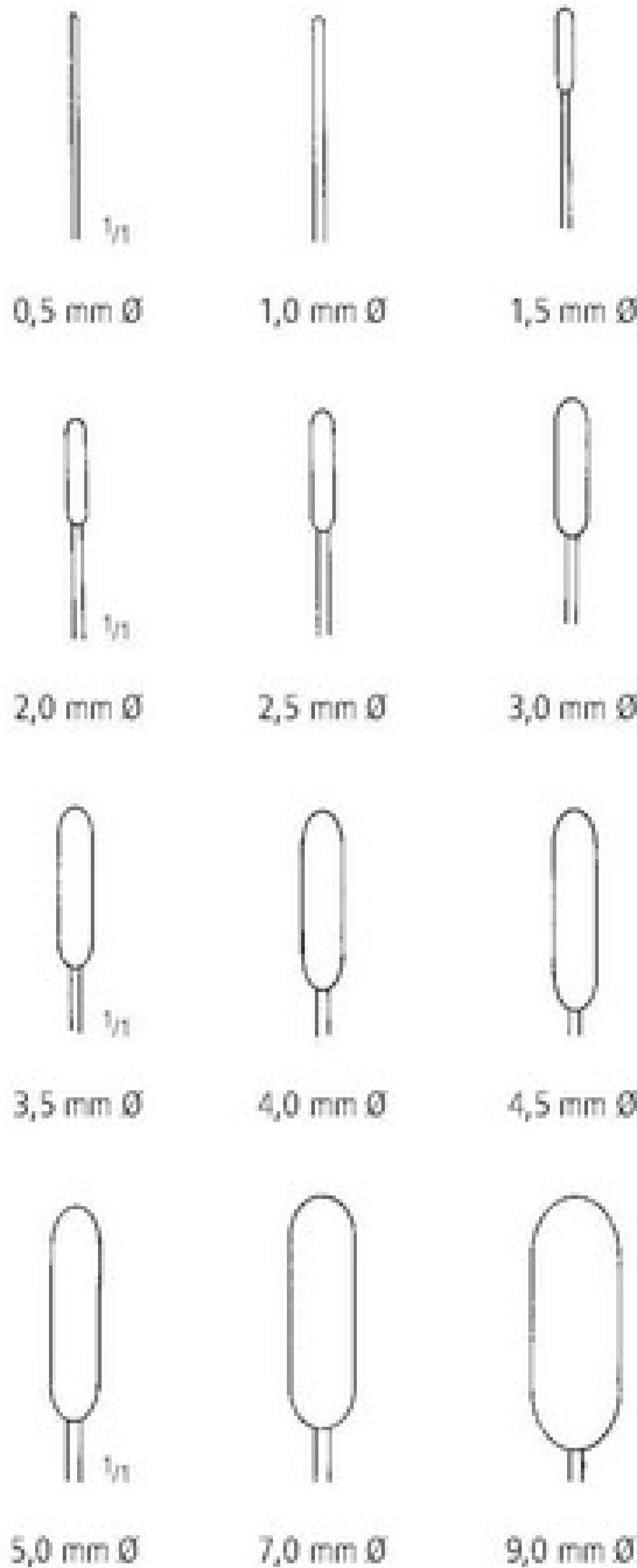

biegsam-malleable-malleables-malleables-malleabili

mm Ø	19,0 cm / 7 1/2"	35,0 cm / 14"
0,5	AL 200/05	AL 201/05
1,0	AL 200/10	AL 201/10
1,5	AL 200/15	AL 201/15
2,0	AL 200/20	AL 201/20
2,5	AL 200/25	AL 201/25
3,0	AL 200/30	AL 201/30
3,5	AL 200/35	AL 201/35
4,0	AL 200/40	AL 201/40
4,5	AL 200/45	AL 201/45
5,0	AL 200/50	AL 201/50
7,0	AL 200/70	AL 201/70
9,0	AL 200/90	AL 201/90

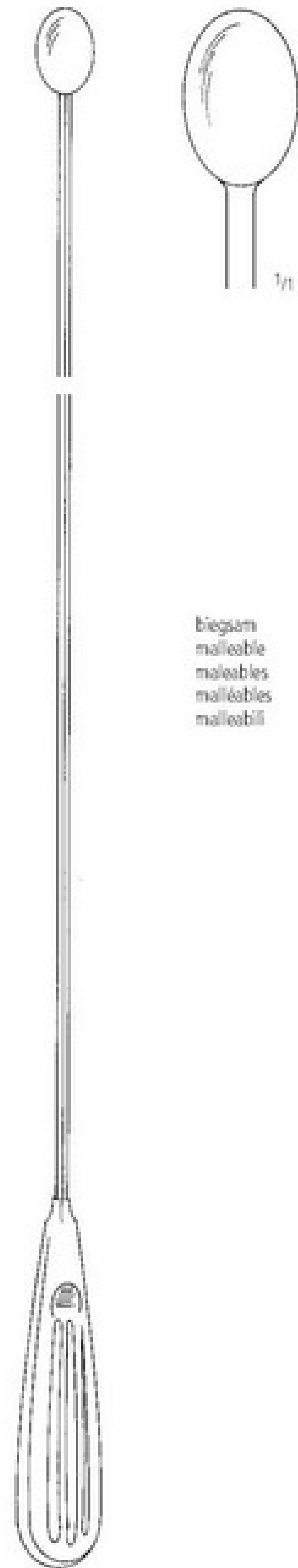

DE BAKEY
 AL 206/50
 50,0 cm/20"

biegsam
 malleable
 malleables
 malleables
 malleabili

Gefäß-Stripper
 Vascular Strippers
 Desobliteradores de vasos
 Tire-veines
 Tiravene

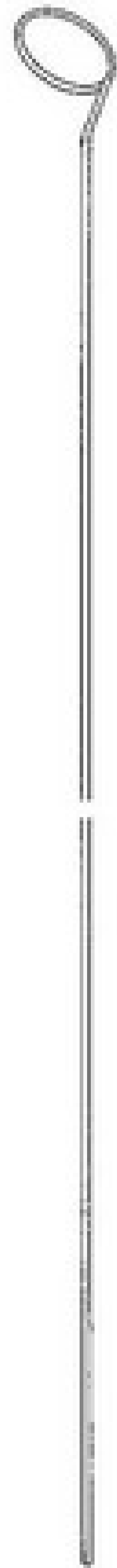

50,0 cm / 20"

○ 1/1
 2,0 mm
 AL 220/02

○ 1/1
 6,0 mm
 AL 220/06

○ 1/1
 10,0 mm
 AL 220/10

○
 3,0 mm
 AL 220/03

○
 7,0 mm
 AL 220/07

○
 12,0 mm
 AL 220/12

○
 4,0 mm
 AL 220/04

○
 8,5 mm
 AL 220/08

○
 14,0 mm
 AL 220/14

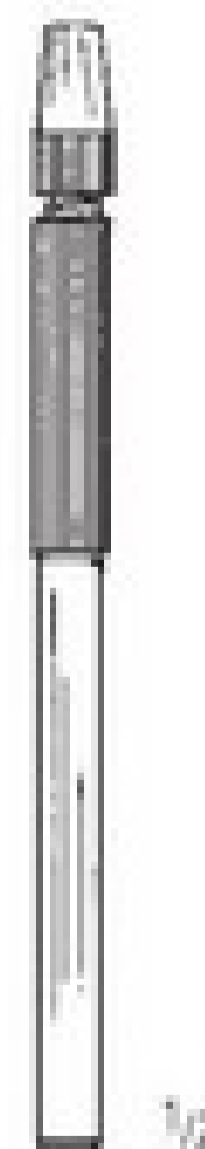

AL 222/12
 12,0 cm / 4 3/4"

SONDEN PROBES SONDAS SONDES SONDE

Fasszangen
Grasping Forceps
Pinzas para coger
Pinces pour saisir
Pinze per afferrare

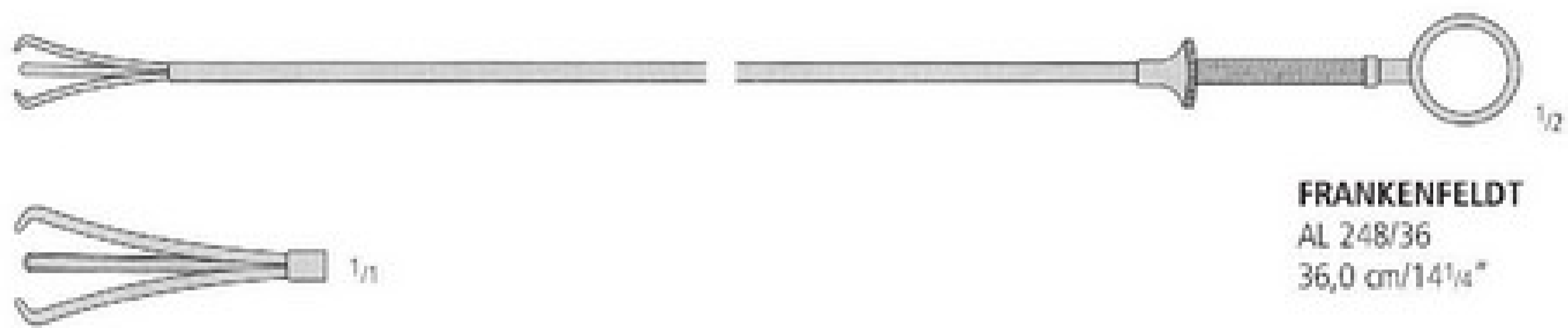

FRANKENFELDT
AL 248/36
36,0 cm / 14¹/₄"

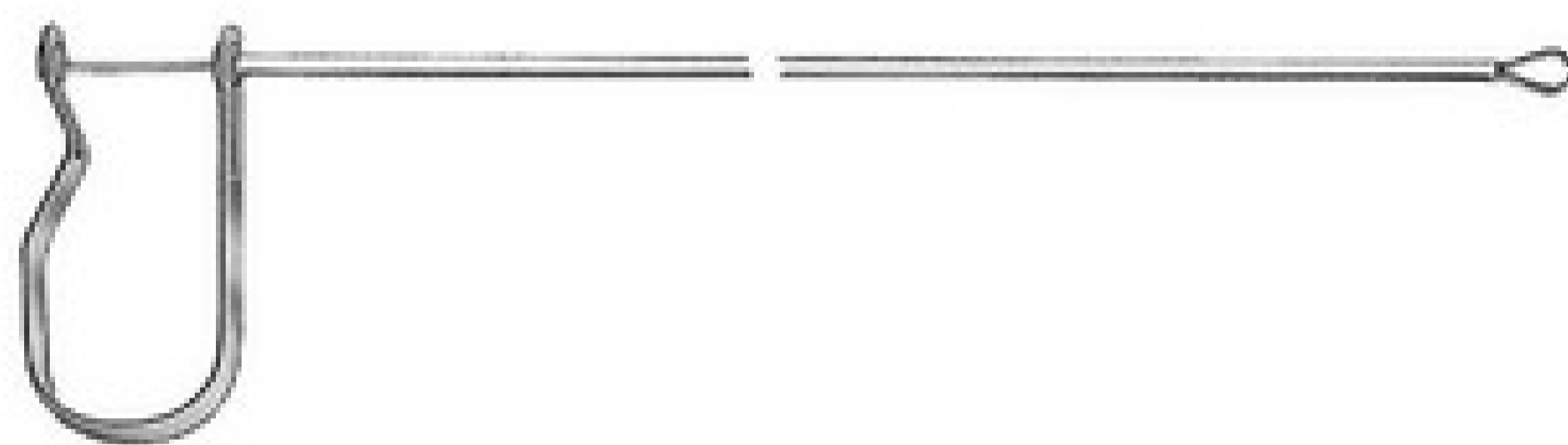

28,0 cm / 11¹/₄"
38,0 cm / 15¹/₄"
45,0 cm / 18"



AL 250/28
AL 250/38
AL 250/45



AL 251/28
AL 251/38
AL 251/45



AL 252/28
AL 252/38
AL 252/45

AA

AB

AC

AD

AE

AF

AK

AL

AM

AO

AP

AR

VERBAND
DRESSING
VENDAJES
PANSEMENTS
BENDAGGI

AM

nopa[®] instruments



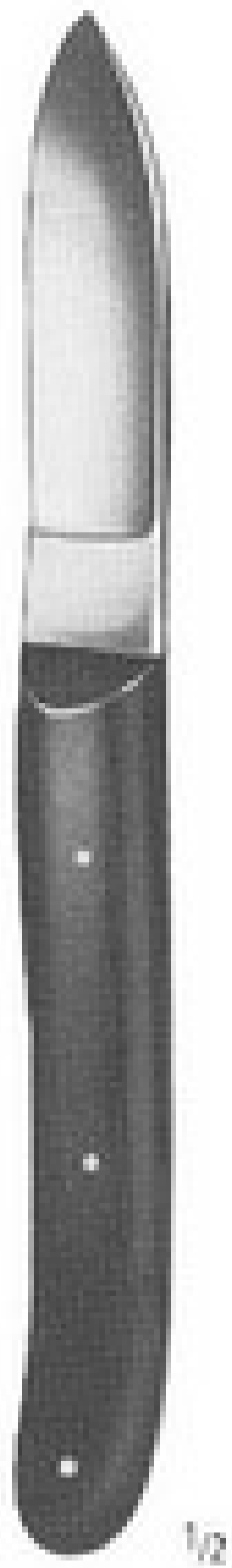

HOPKINS
AM 030/20
20,0 cm/8"

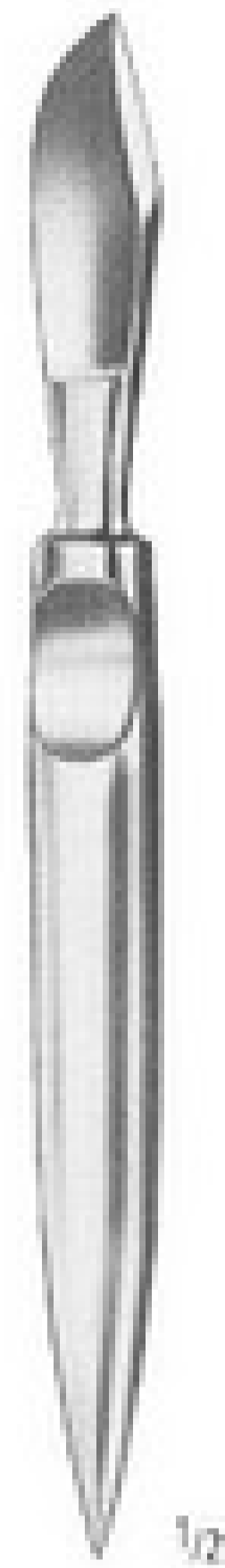

ESMARCH
AM 038/18
18,0 cm/7"

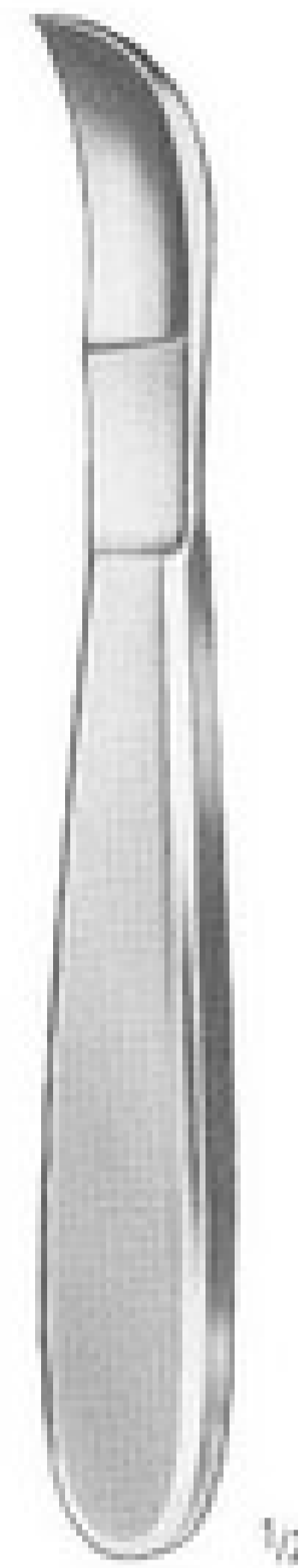

REINER
AM 040/18
18,5 cm/7 1/3"

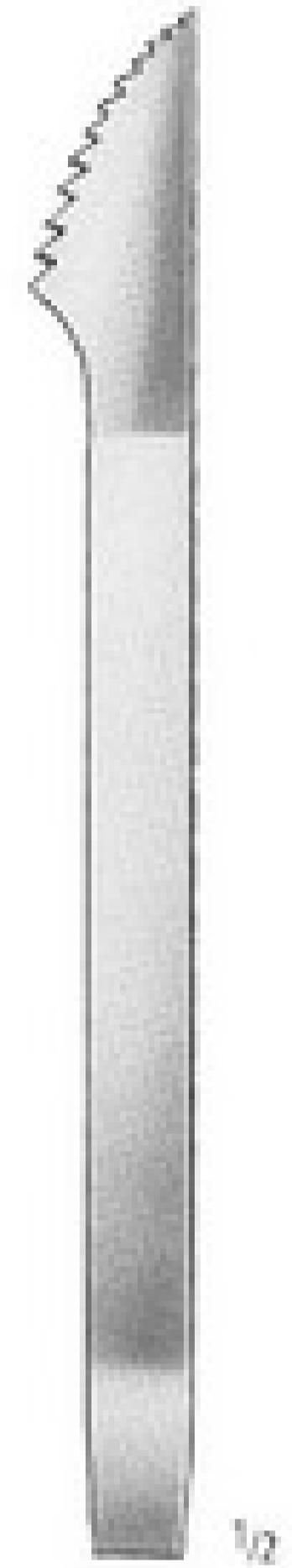

WIGMORE
AM 044/19
19,0 cm/7 1/2"



ENGEL
AM 060/14
14,0 cm/5 1/2"

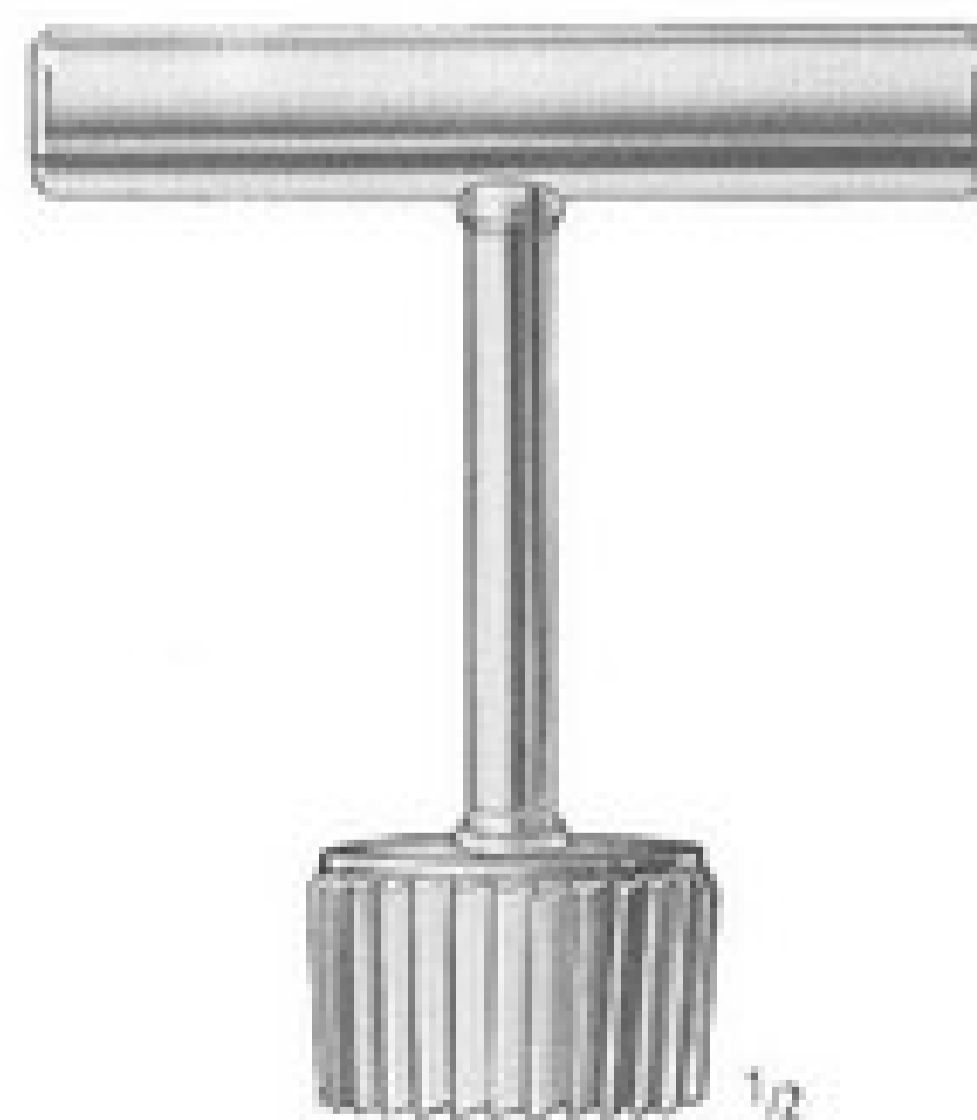

GALT
AM 061/00



BERGMANN
AM 062/18
18,0 cm/7"

AA
AB
AC
AD
AE
AF
AK
AL
AM

AO
AP
AR



HENNIG
AM 100/28
28,0 cm/11"

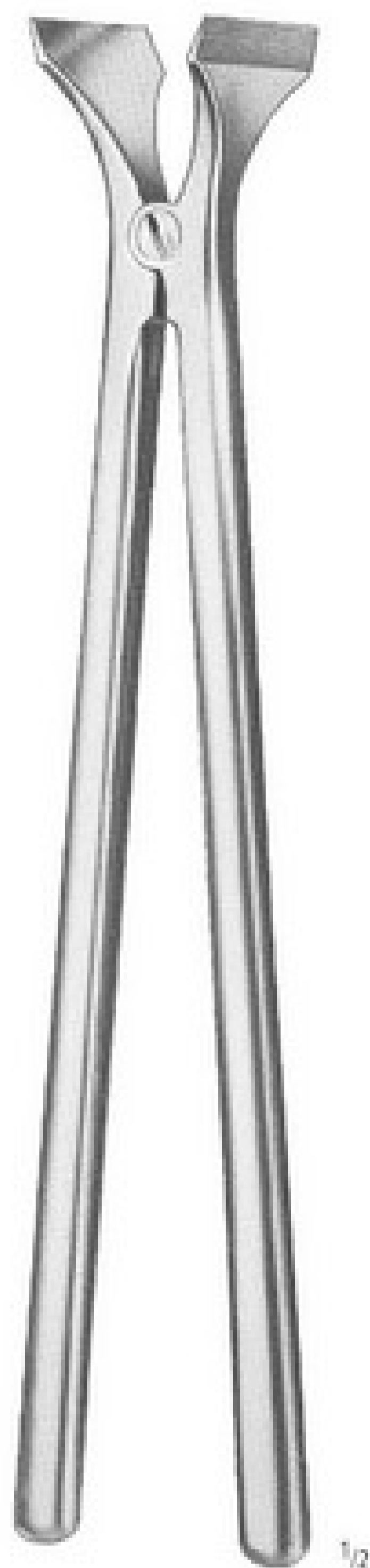

BEESON
AM 102/30
30,0 cm/12"



MOD. USA
AM 120/23
23,0 cm/9"



WOLFF
 18,0 cm / 7" AM 200/18
 24,0 cm / 9½" AM 200/24



STILLE
 20,0 cm / 8" AM 250/20
 23,0 cm / 9" AM 250/23
 26,0 cm / 10½" AM 250/26
 37,0 cm / 14½" AM 250/37

OSCInopa



AM 300/00 = 220 V
(+ AM 308/50 + AM 308/65 + AM 312/23)

AM 300/01 = 110 V
(+ AM 308/50 + AM 308/65 + AM 312/23)

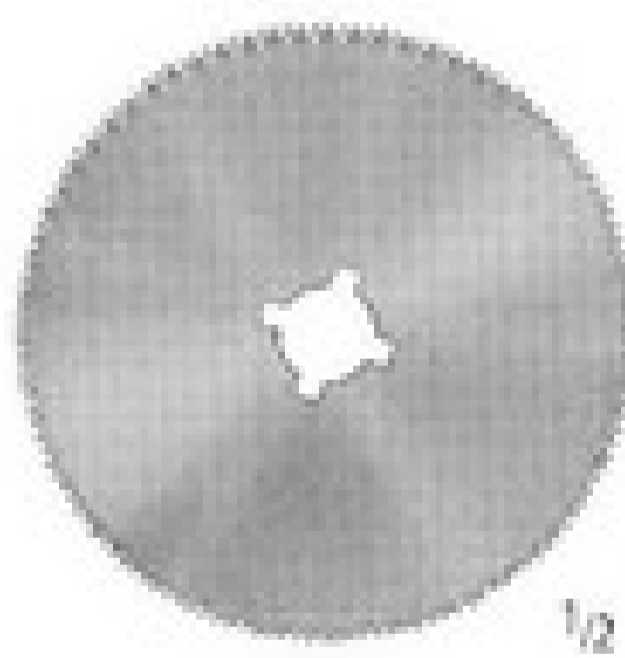

Für Hartverband
For hard plaster
Para yeso duro
Pour plâtre dur
per bendaggi gessati

AM 308/50 = 50 mm Ø
AM 308/65 = 65 mm Ø



AM 312/23

PUNKTION/KANÜLEN
PUNCTURE/SPECIAL NEEDLES
PUNCION/AGUJAS ESPECIALES
PONCTION/AIGUILLES SPECIALES
PUNTURA/AGHI SPECIALI

A0

nopa[®] instruments



Trokare
Trocars
Trocars
Trocarts
Trequarti

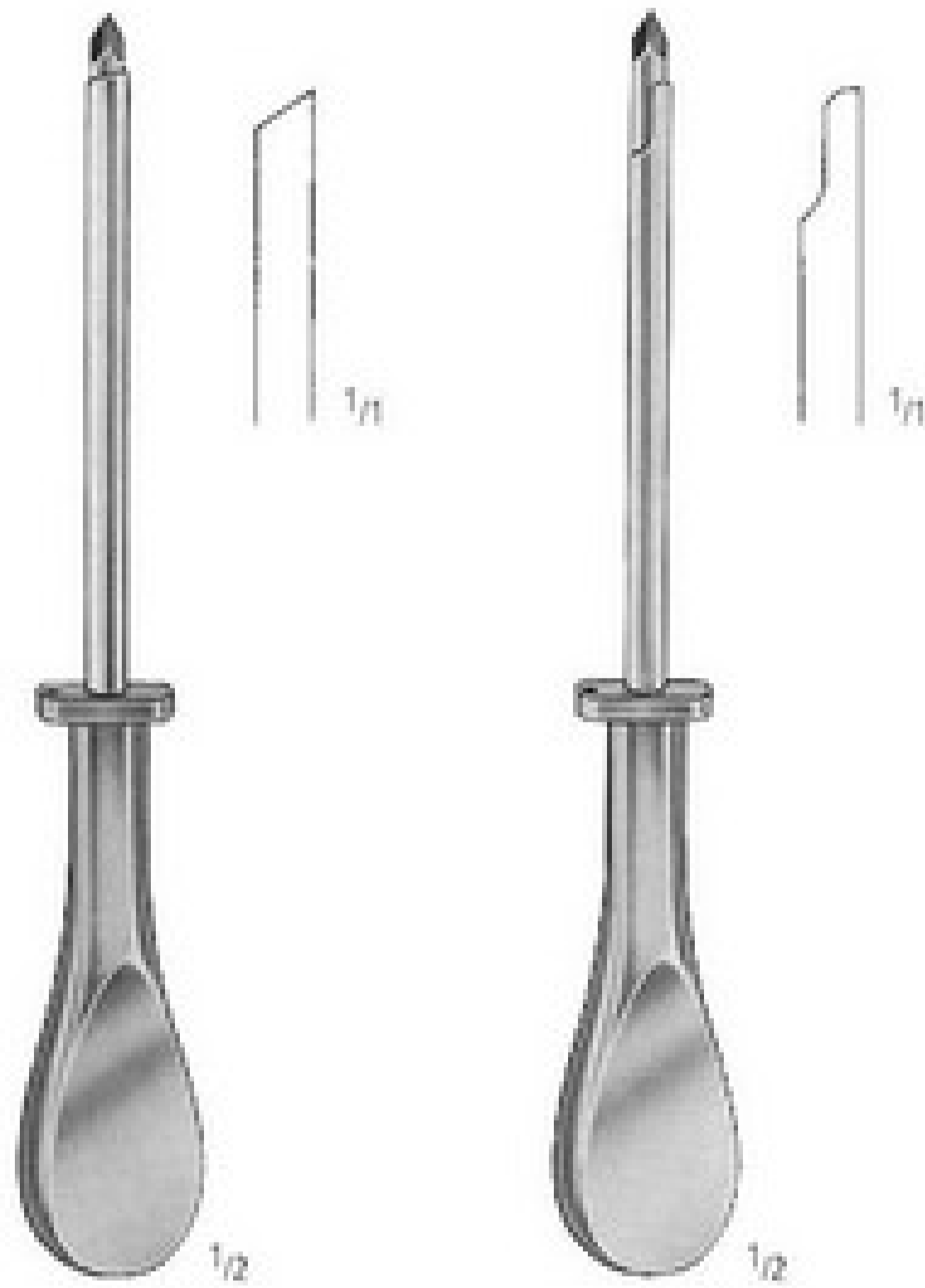

SINUSCOPY

L (mm)	Ø 3,3 mm	Ø 5,0 mm	Ø 5,0 mm
75	AO 080/01		
85		AO 080/10	AO 080/25
110		AO 080/15	

AO 110/03
Satz zu 3 Stück
Set of 3 pieces
Juego de 3 piezas
Jeu de 3 pièces
Serie da 3 pezzi



AO 110/04
Satz zu 4 Stück
Set of 4 pieces
Juego de 4 piezas
Jeu de 4 pièces
Serie da 4 pezzi

UNIVERSAL



STANDARD

Ø 3 mm	AO 120/30
Ø 4 mm	AO 120/40
Ø 5 mm	AO 120/50
Ø 6 mm	AO 120/60



STANDARD

AO 122/30
AO 122/40
AO 122/50
AO 122/60



STANDARD

AO 124/30
AO 124/40
AO 124/50
AO 124/60

AA
AB
AC
AD
AE
AF
AK
AL
AM
AO
AP
AR

Trokare
Trocars
Trocares
Trocart
Trequart

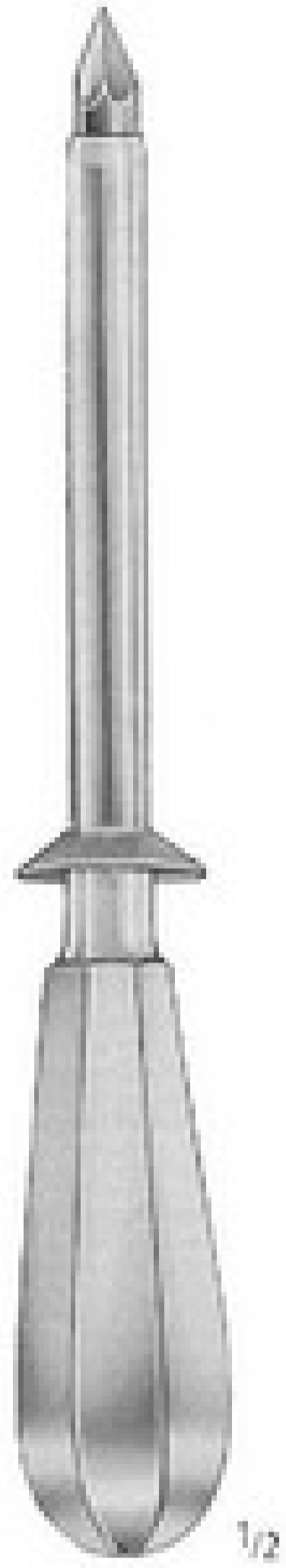
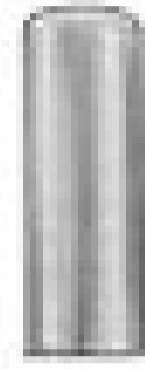

NELSON
21,0 cm/8¹/₄"

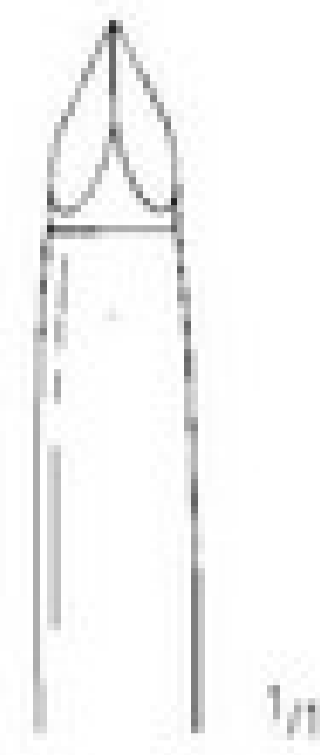

Fig. 1
AO 140/01
7,5 mm

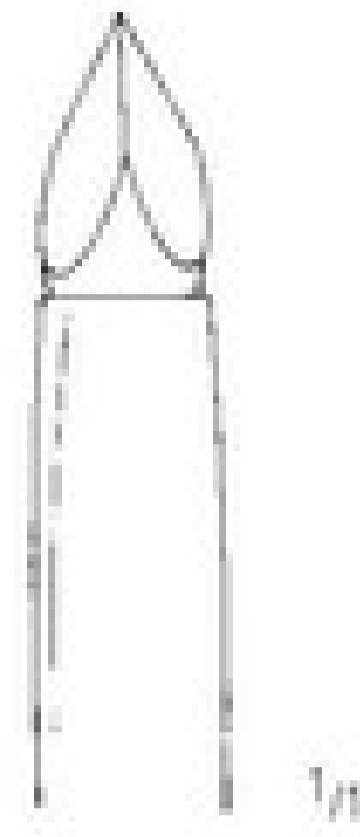

Fig. 2
AO 140/02
9,5 mm

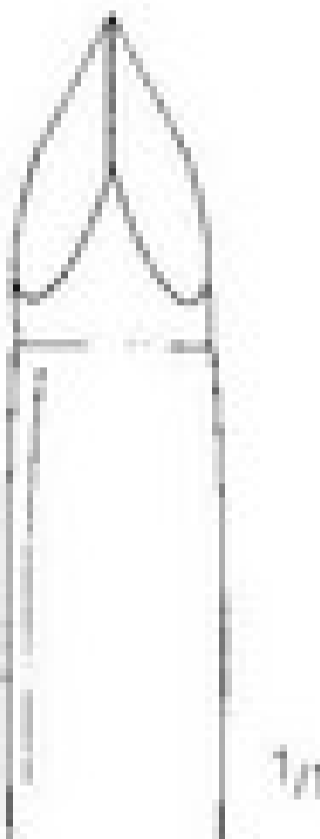

Fig. 3
AO 140/03
11,0 mm

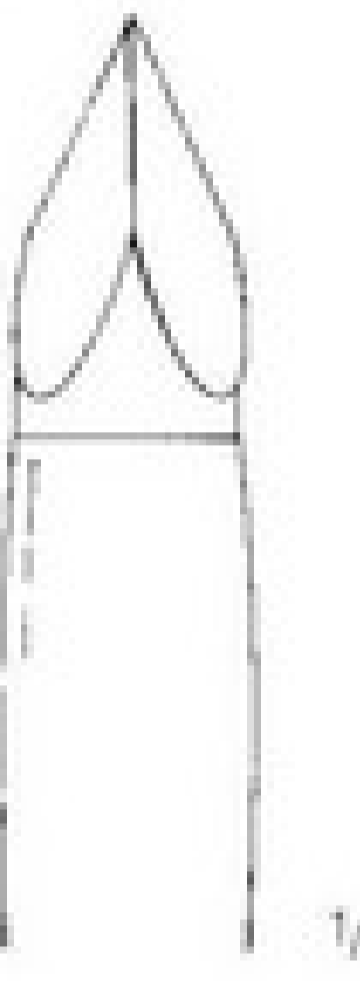
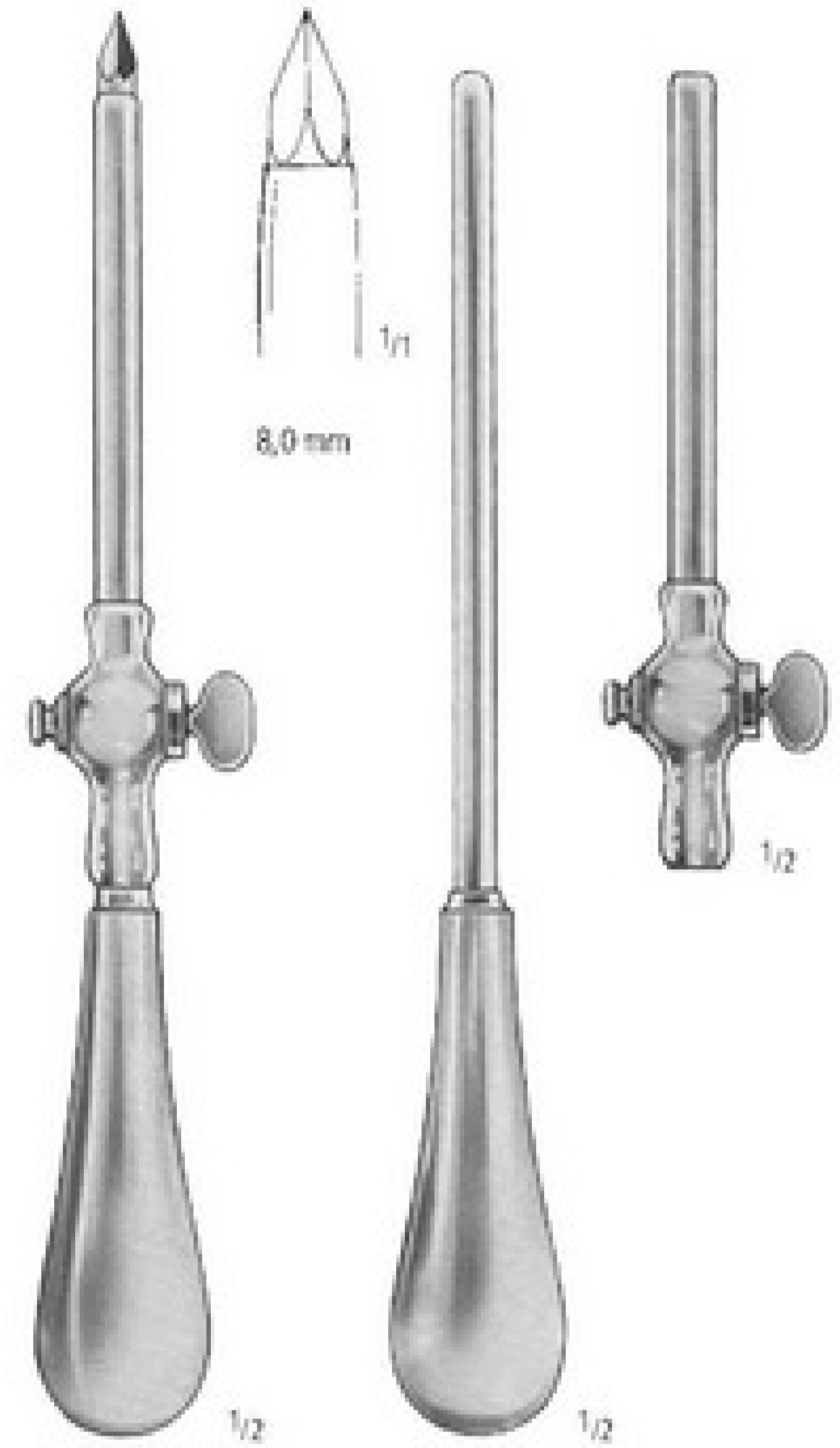
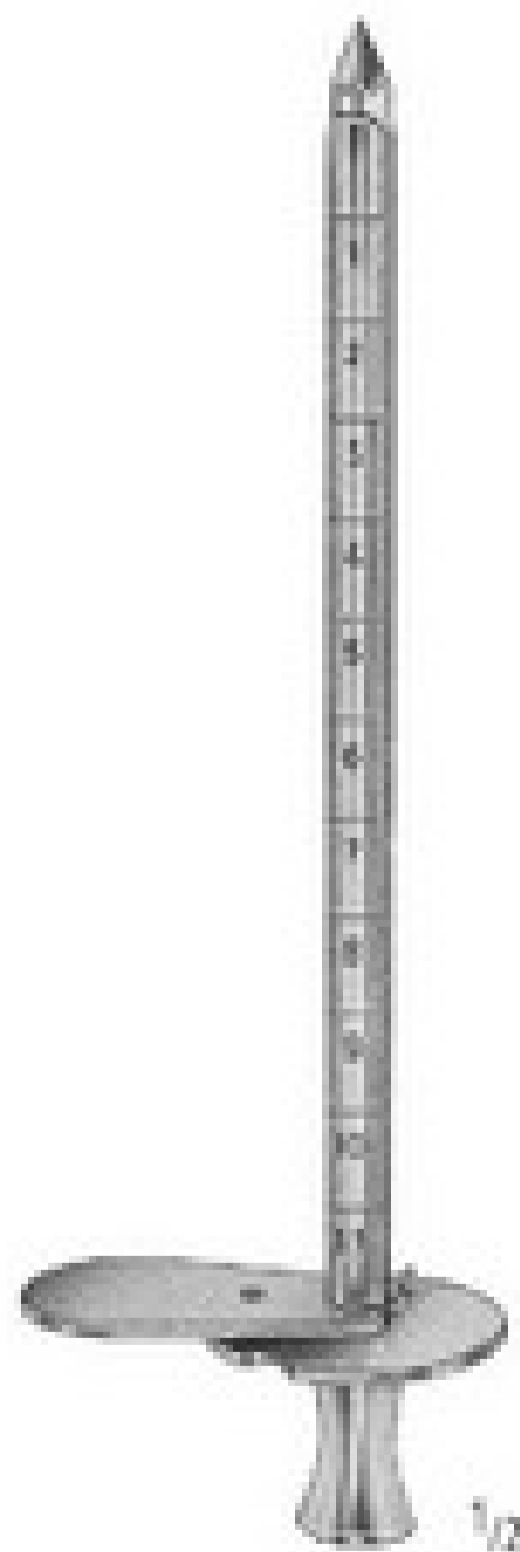

Fig. 4
AO 140/04
12,5 mm



BUELAU
AO 144/00
24,0 cm/9¹/₂"



CAMPBELL
AO 148/06
16,0 cm/6¹/₄"

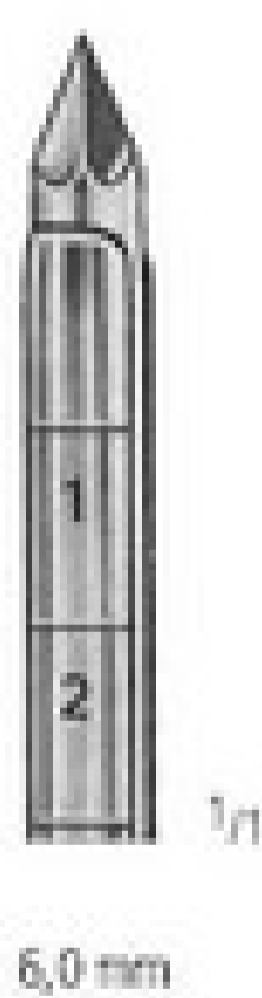

6,0 mm

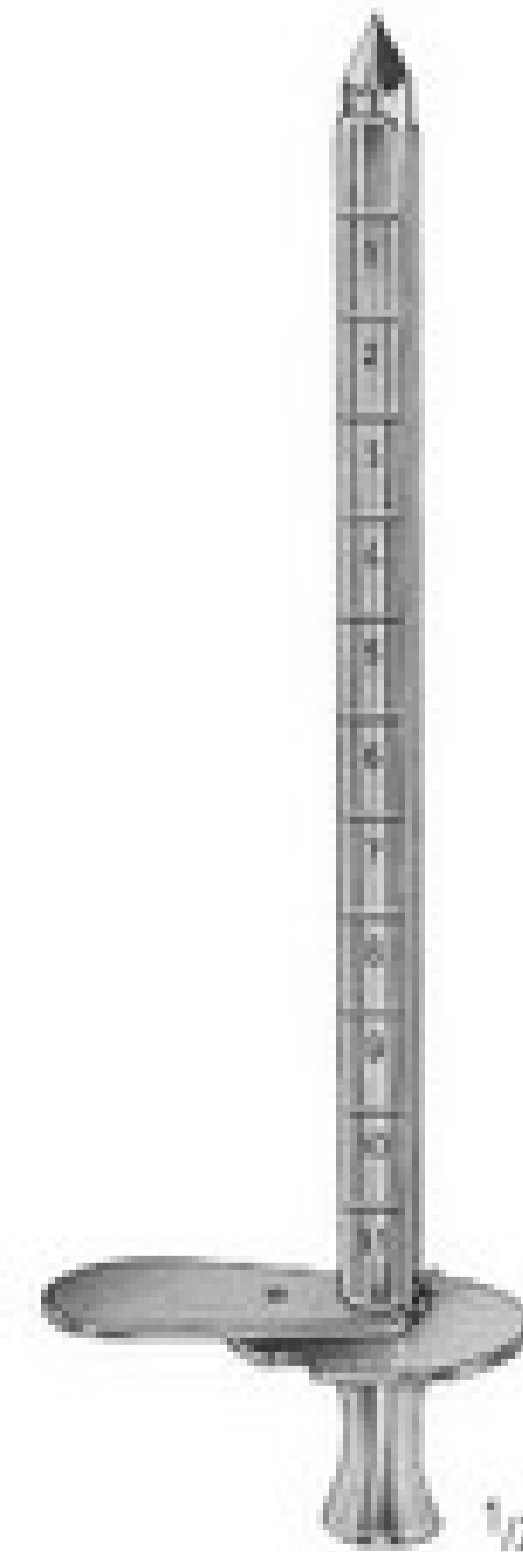

CAMPBELL
AO 148/08
16,0 cm/6¹/₄"

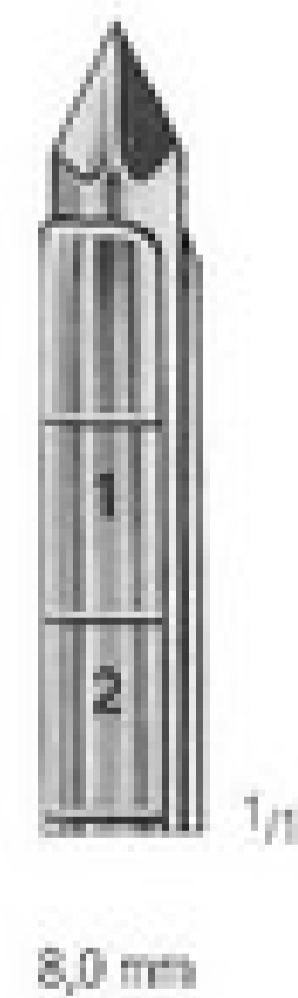

8,0 mm

Trokare
Trocars
Trocares
Trocaris
Trequarti

AA

AB

AC

AD

AE

AF

AK

AL

AM

AO

AP

AR

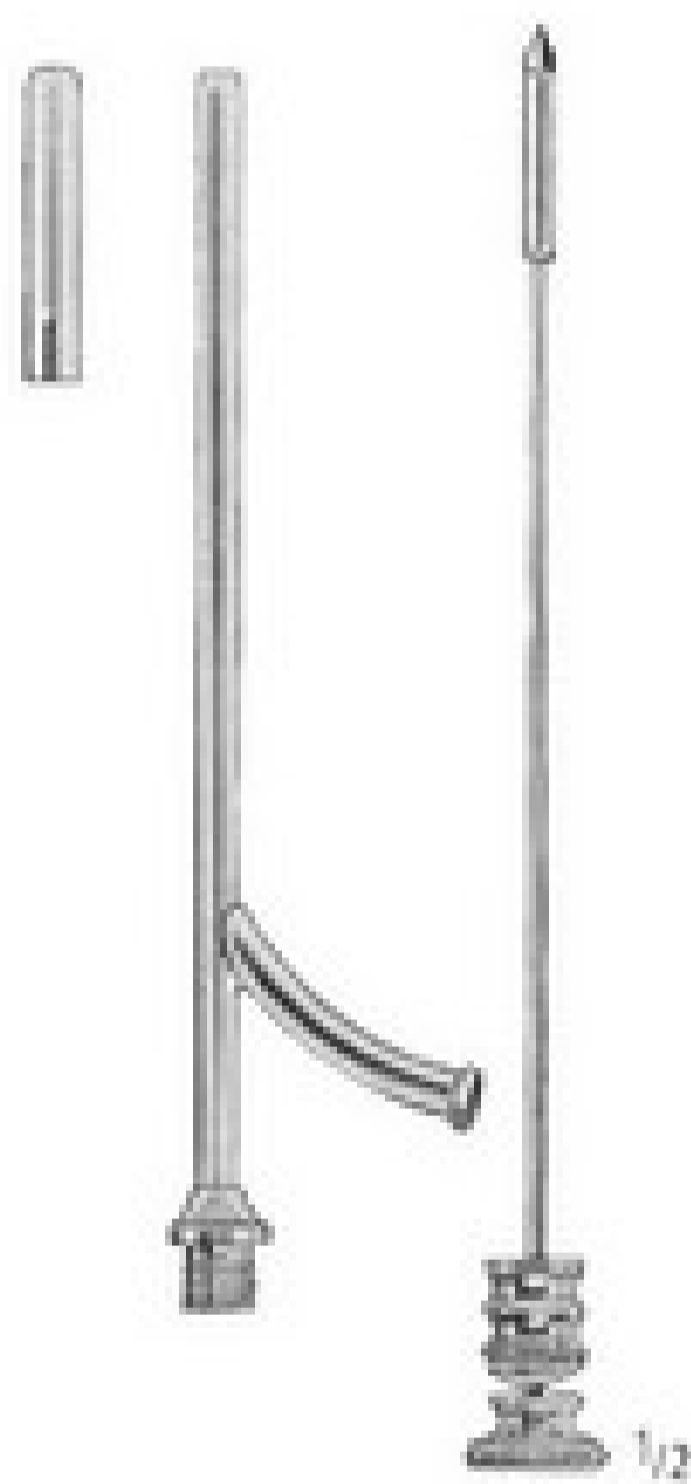

OCHSNER
 Charr. 10 AO 160/10
 Charr. 12 AO 160/12
 Charr. 14 AO 160/14
 Charr. 16 AO 160/16
 Charr. 18 AO 160/18
 Charr. 20 AO 160/20

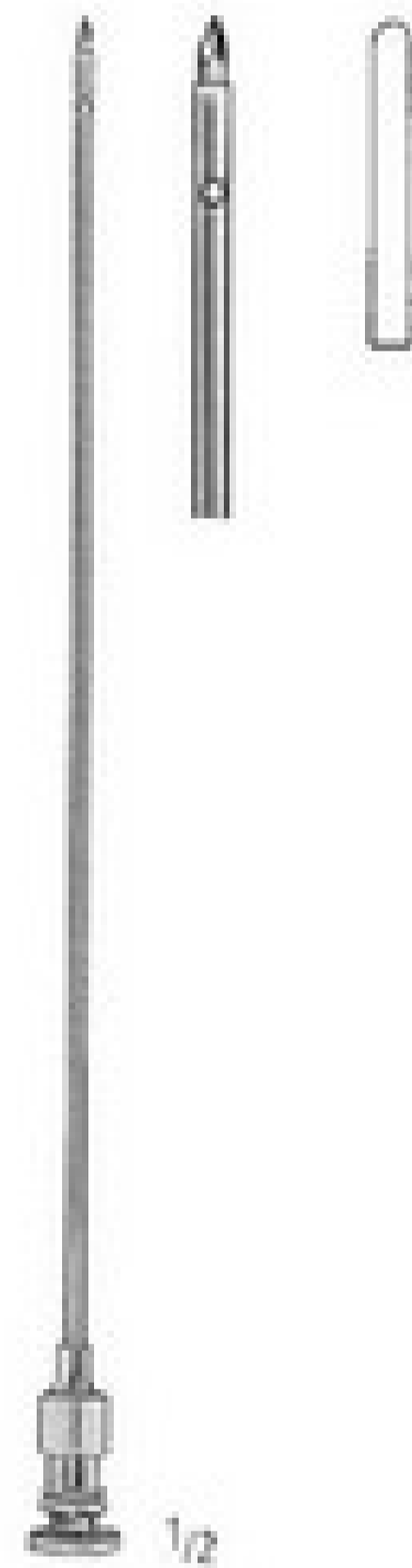

LANDAU
 AO 170/16
 16,0 cm/6 1/4"
 2,0 mm



JOHANSSON
 AO 172/00
 18,0 cm/7"
 9,0 mm

Trokare
Trocars
Trocares
Trocart
Trequart

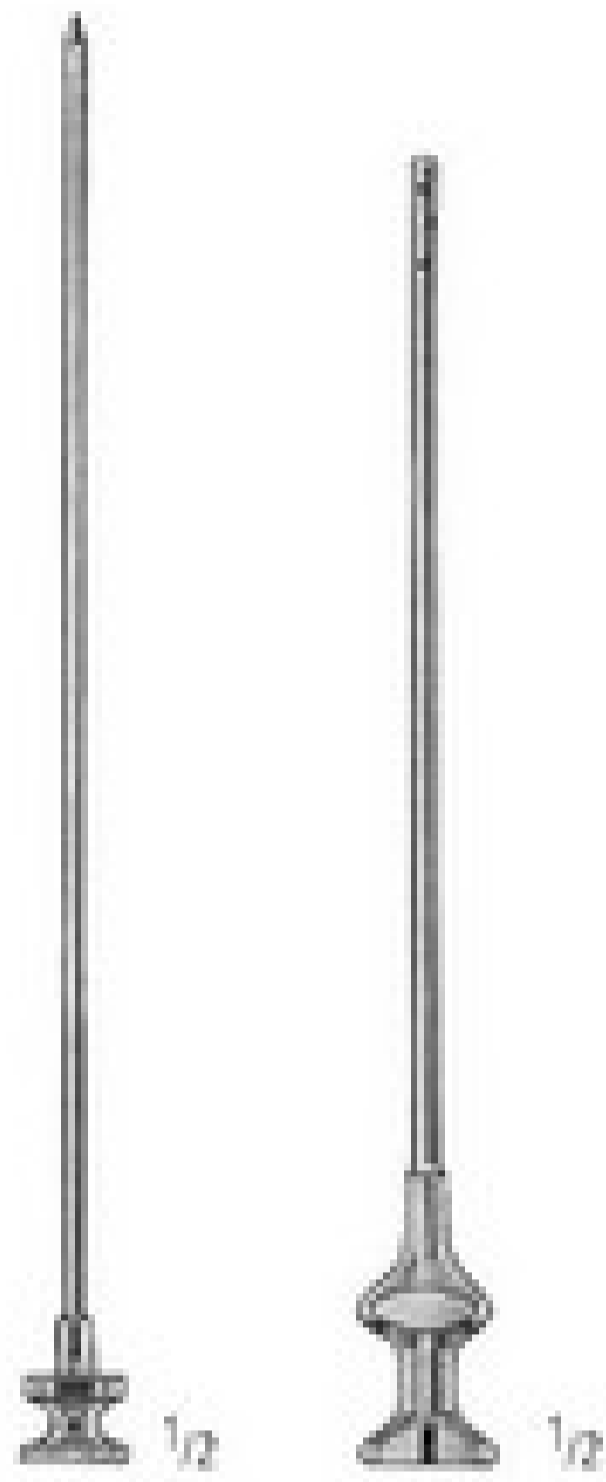

EICKEN

1,8 x 105 mm AO 176/18
2,0 x 105 mm AO 176/20
3,0 x 105 mm AO 176/30



LIGHTWITZ

AO 180/00
1,8 mm



LIGHTWITZ

AO 182/00
1,6 mm



DOUGLAS

AO 185/00
3,0 mm



PIERCE

AO 190/30 Ø 3,0 mm
AO 190/40 Ø 4,0 mm
AO 190/50 Ø 5,0 mm
Ø 5,5 mm



KRAUSE

AO 194/30
AO 194/40
AO 194/50
AO 194/55

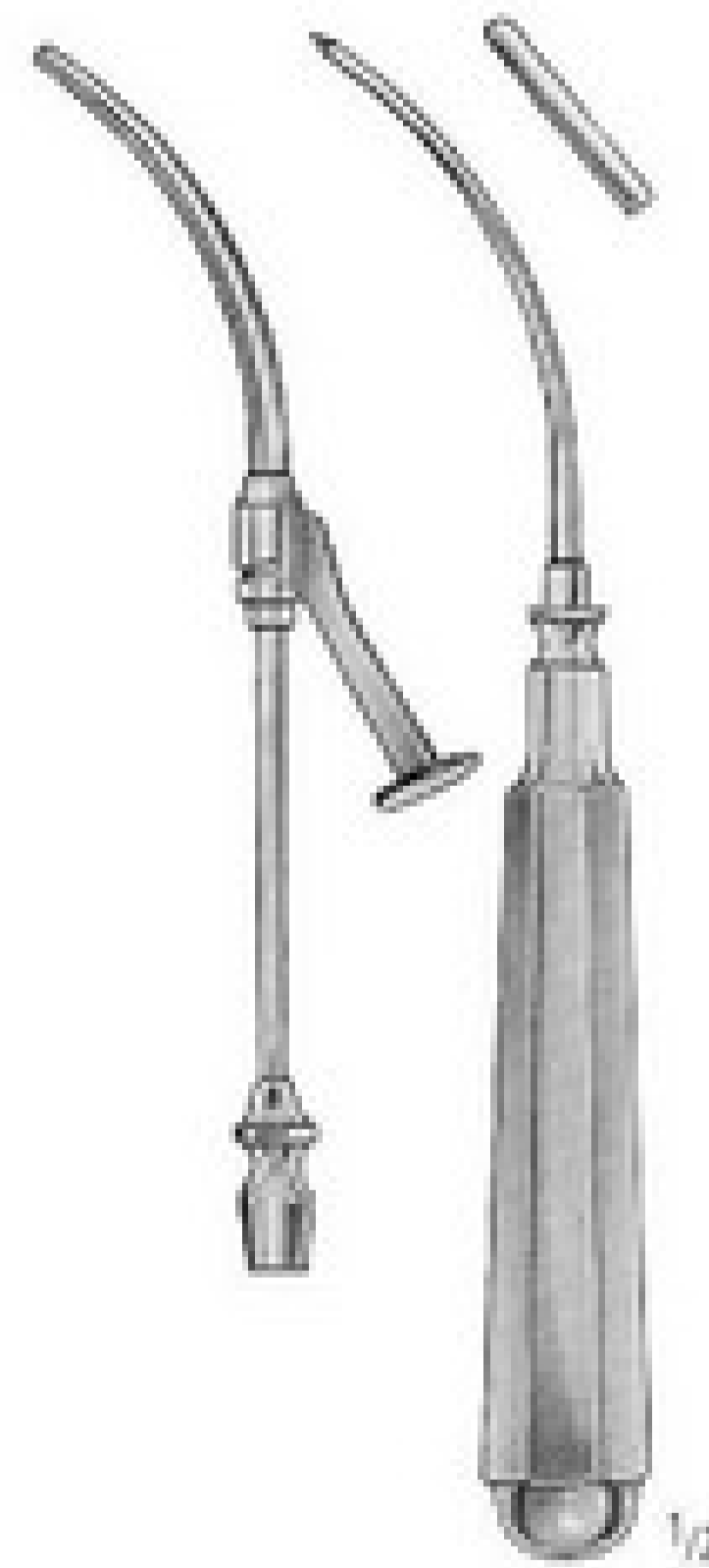

COAKLEY

AO 200/16
2,25 mm

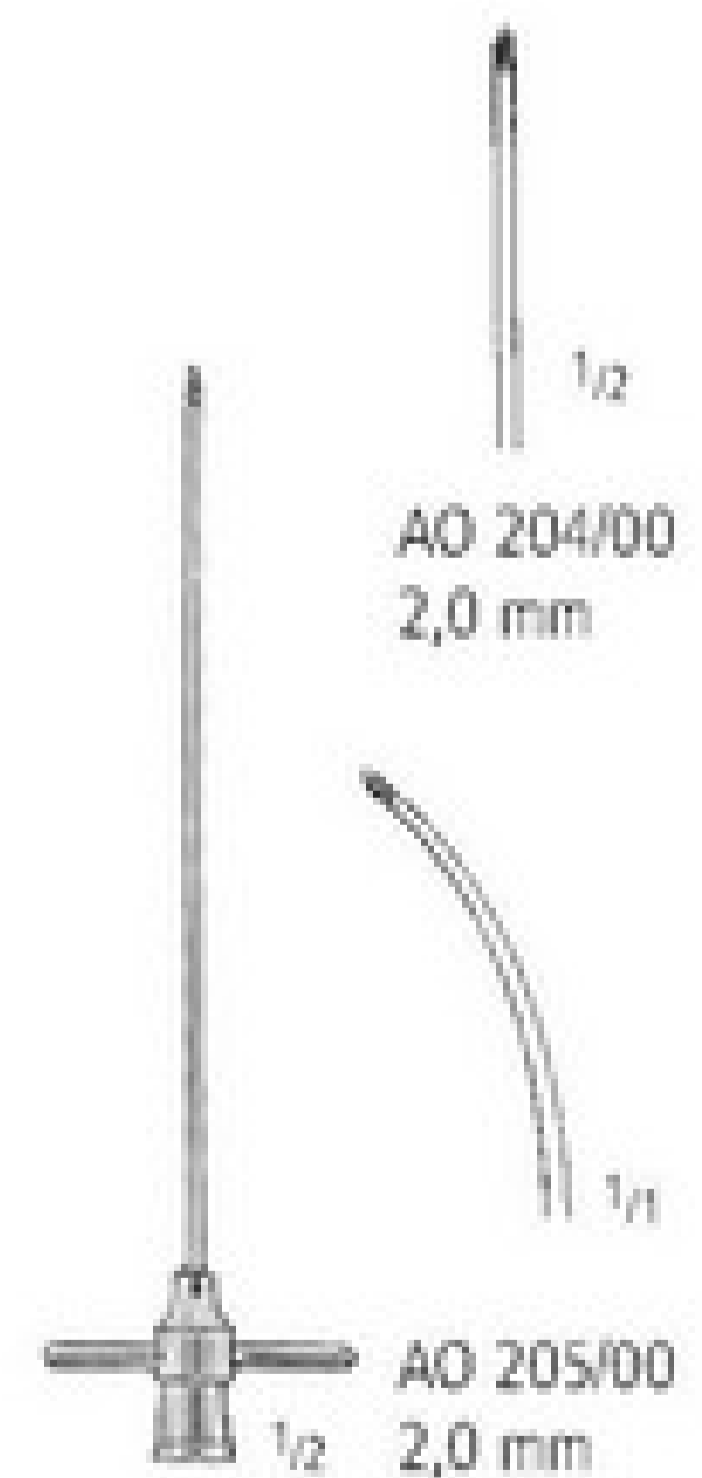

RUSKIN

AO 204/00
2,0 mm
AO 205/00
2,0 mm

Saugrohre
Suction Tubes
Tubos de aspiración
Canules d'aspiration
Cannule per aspirazione



YANKAUER
AO 400/00
27,0 cm/11"



WALTON-YANKAUER
AO 404/00
32,5 cm/13"



ANDREWS-PYNCHON
AO 406/00
23,5 cm/9 1/8"



DE BAKEY
AO 408/00
27,5 cm/10 3/4"

AA
AB
AC
AD
AE
AF
AG
AH
AI
AJ
AK
AL
AM
AN
AO
AP
AR

Saugrohre
Suction Tubes
Tubos de aspiración
Canules d'aspiration
Cannule per aspirazione



COUPLAND
AO 410/00

BYRD
1,5 mm AO 412/15
2,5 mm AO 412/25
3,5 mm AO 412/35

POOLE
AO 420/22
10,0 mm

POOLE
AO 421/22
8,0 mm

BABY-POOLE
AO 422/20
5,5 mm

Saugrohre
Suction Tubes
Tubos de aspiración
Canules d'aspiration
Cannule per aspirazione

8,0 mm



COOLEY
AO 424/01
33,0 cm/13"

8,0 mm

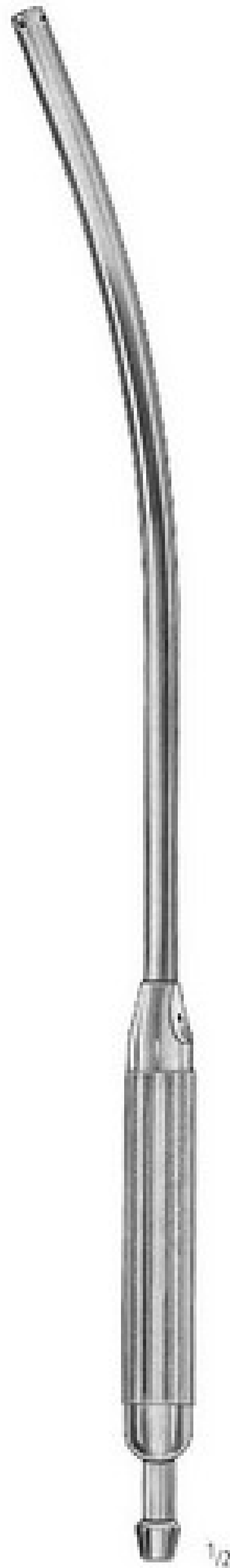

COOLEY
AO 424/02
35,0 cm/14"

6,0 mm



COOLEY
AO 424/03
30,0 cm/12"

10,0 mm

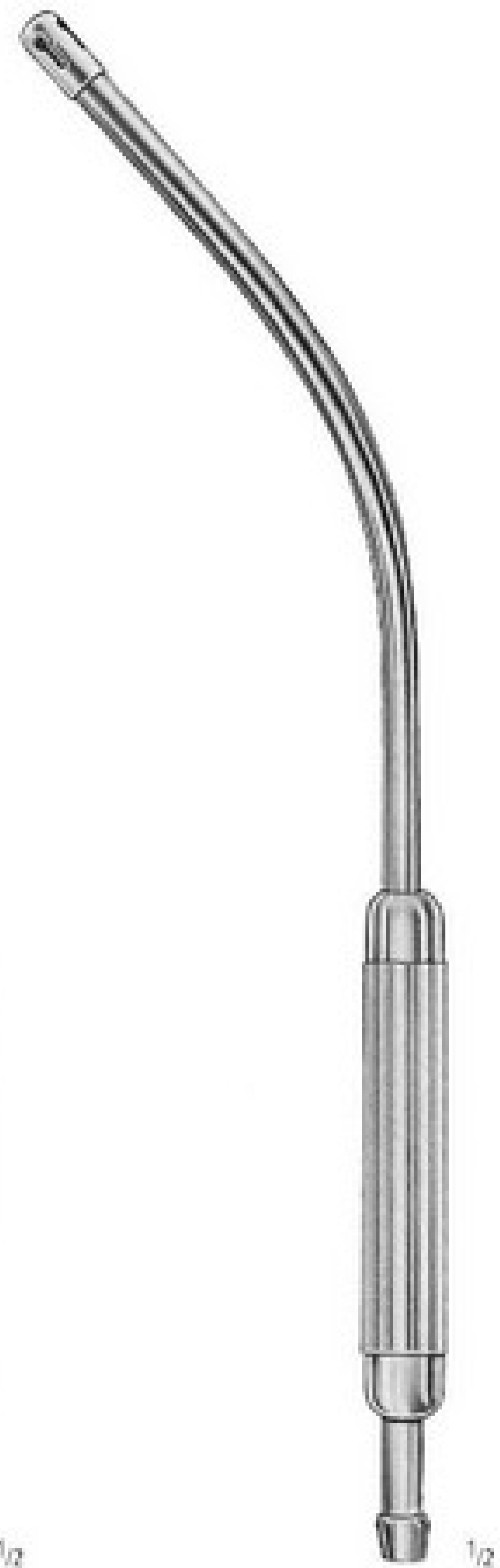

COOLEY
AO 424/04
31,0 cm/12 1/4"

AA

AB

AC

AD

AE

AF

AK

AL

AM

AO

AP

AR

Saugrohre
Suction Tubes
Tubos de aspiración
Canules d'aspiration
Cannule per aspirazione

complete with suction tube
+ cannula 0,4 mm
+ cannula 0,6 mm
+ cannula 0,8 mm



FRAZIER		PLESTER	
6 Charr.	AO 430/06	1,5 mm	AO 432/15
8 Charr.	AO 430/08	2,0 mm	AO 432/20
10 Charr.	AO 430/10	2,5 mm	AO 432/25
12 Charr.	AO 430/12	3,0 mm	AO 432/30

FERGUSSON	
5 Charr.	AO 434/05
6 Charr.	AO 434/06
7 Charr.	AO 434/07
8 Charr.	AO 434/08
9 Charr.	AO 434/09
10 Charr.	AO 434/10
12 Charr.	AO 434/12

EICKEN-KILLIAN	
AO 436/03	13,0 cm/5"
	Ø 3 mm

WULLSTEIN MICRO	
AO 438/00	

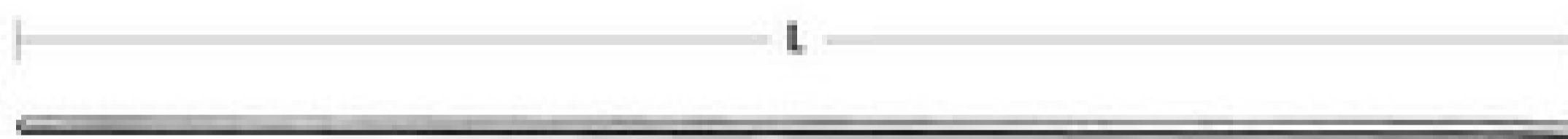

	L	L	L	L
	130 mm	150 mm	180 mm	220 mm
Ø 1,5 mm	AO 440/13	AO 440/15	AO 440/18	AO 440/22
Ø 2,0 mm	AO 441/13	AO 441/15	AO 441/18	AO 441/22
Ø 2,5 mm	AO 442/13	AO 442/15	AO 442/18	AO 442/22
Ø 3,5 mm	AO 443/13	AO 443/15	AO 443/18	AO 443/22

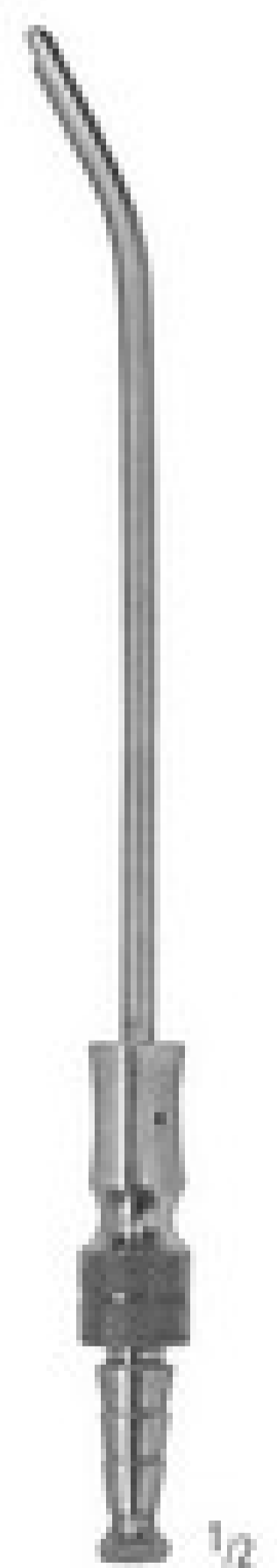

ADSON
AO 450/04
21,0 cm/8 1/4"
Ø 4,0 mm

Biopsie-Kanülen
 Biopsy Needles
 Aguja para biopsia
 Aiguilles à biopsie
 Aghi per biopsia



FRANKLIN-SILVERMAN
 2,0 x 100 mm AO 610/20
 2,5 x 145 mm AO 610/25



FRANKLIN-SILVERMAN
 2,0 x 100 mm AO 614/20
 2,5 x 145 mm AO 614/25



AA
 AB
 AC
 AD
 AE
 AF
 AK
 AL
 AM
AO
 AP
 AR

Biopsie-Kanülen
 Biopsy Needles
 Agujas para biopsia
 Aiguilles à biopsie
 Aghi per biopsia

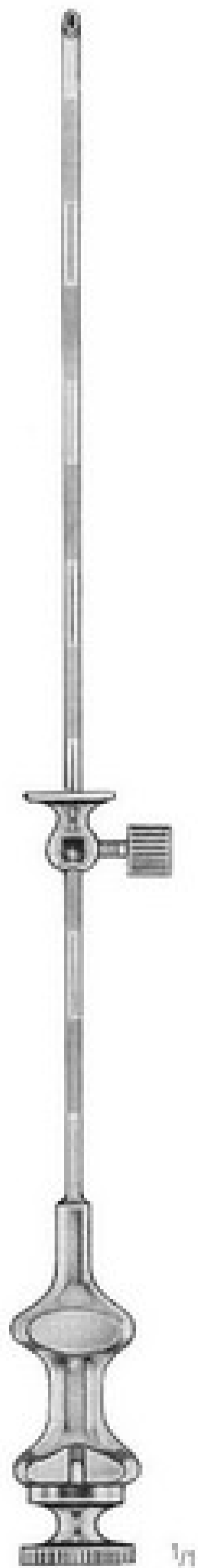

SALAH
 AO 630/16
 1,6 x 50 mm

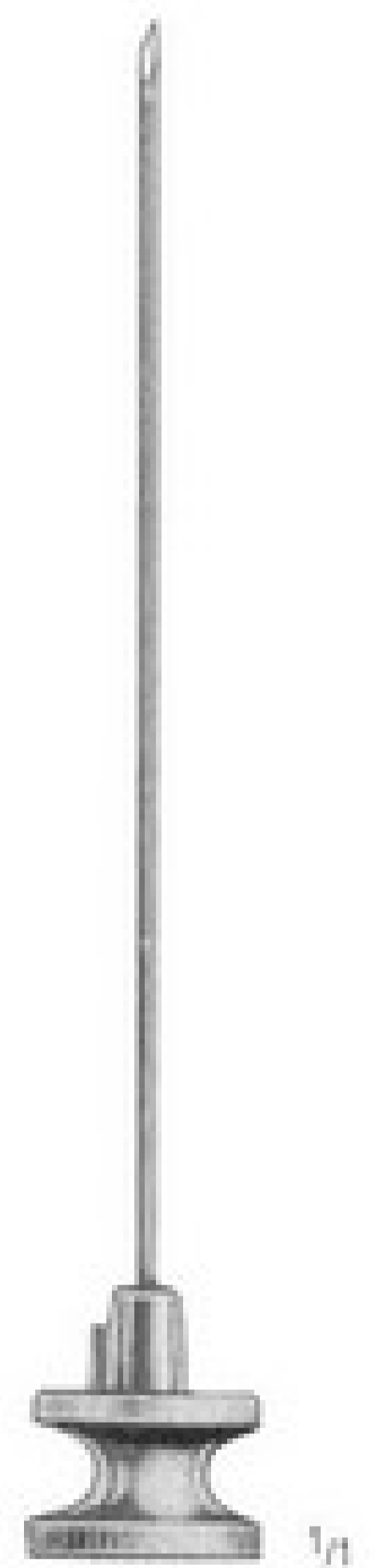
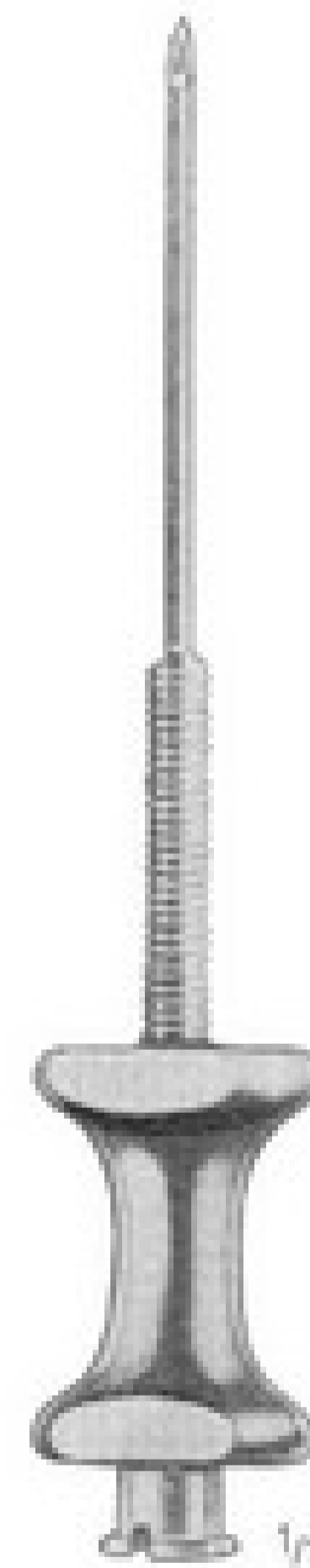
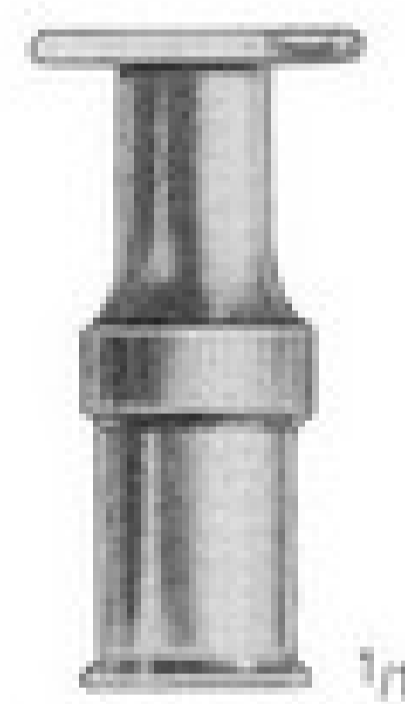

KLIMA-ROSSEGGER
 AO 660/18
 1,8 x 35 mm

Biopsie-Kanülen
Biopsy Needles
Agujas para biopsia
Aiguilles à biopsie
Aghi per biopsia

AA

AB

AC

AD

AE

AF

AK

AL

AM

AO

AP

AR

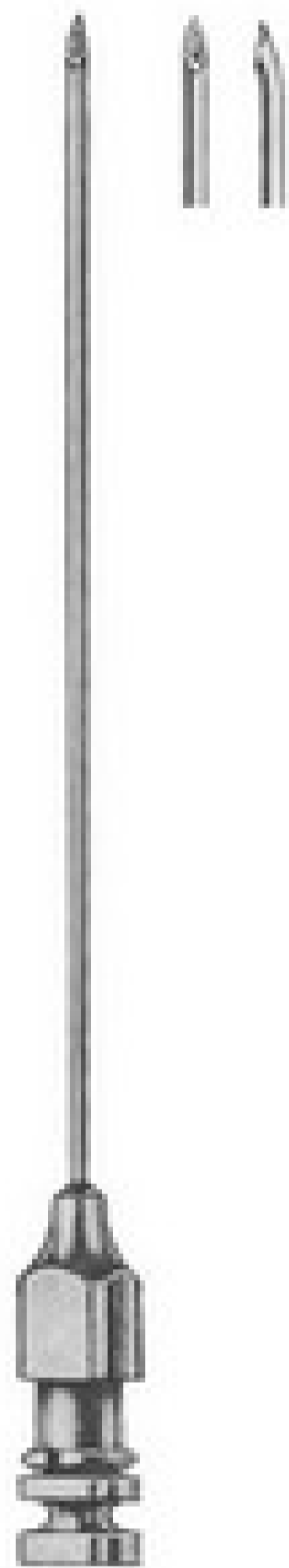

TUOHY

- 1,2 x 80 mm AO 690/16
- 1,4 x 80 mm AO 690/17
- 1,6 x 80 mm AO 690/18

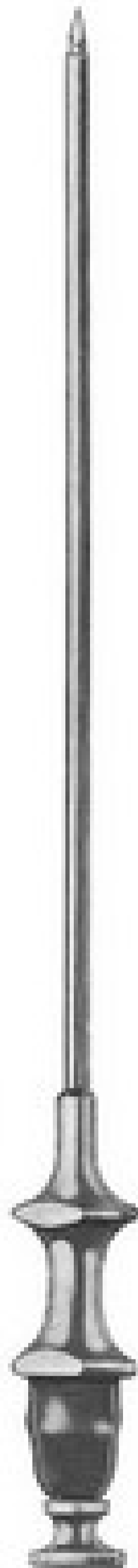

TROCAR

- Ø 1,4 mm AO 718/14
- Ø 1,8 mm AO 718/18

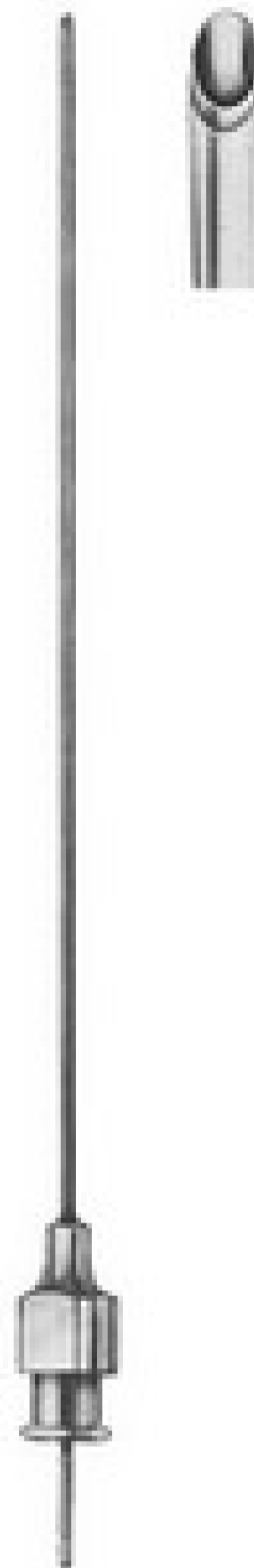

MENGHINI

- 1,0 x 35 mm AO 715/01
- 1,0 x 70 mm AO 715/02
- 1,2 x 70 mm AO 715/03
- 1,2 x 100 mm AO 715/04
- 1,4 x 70 mm AO 715/05
- 1,4 x 100 mm AO 715/06
- 1,6 x 70 mm AO 715/07
- 1,8 x 100 mm AO 715/08

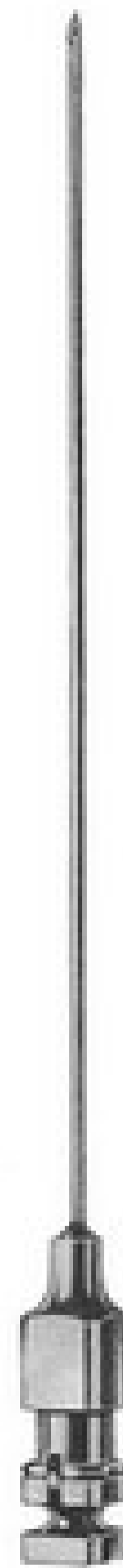

QUINKE

- 0,7 x 76 mm AO 720/01
- 0,7 x 89 mm AO 720/02
- 1,0 x 76 mm AO 720/03
- 1,0 x 89 mm AO 720/04
- 1,2 x 76 mm AO 720/05
- 1,2 x 89 mm AO 720/06

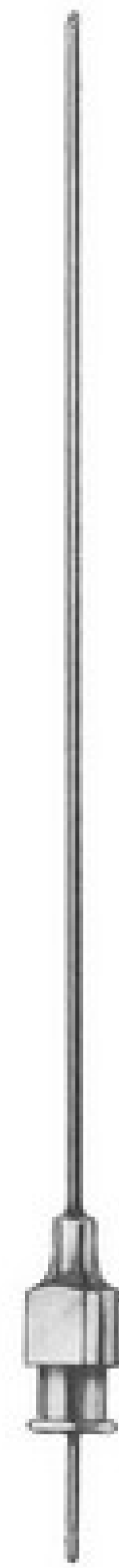

MENGHINI

- 1,4 x 168 mm AO 717/14
- 1,8 x 168 mm AO 717/18

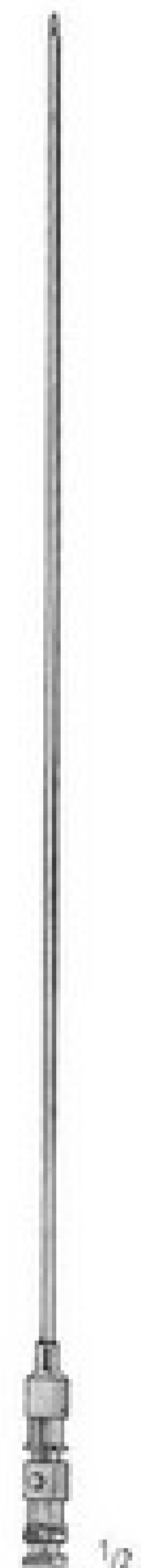

- AO 722/00
- 2,0 x 220 mm
- Arteriographie-Kanüle
- Arteriography needle
- Aguja de arteriografía
- Aiguille pour artériographie
- Ago per arteriografia

1/2

Spezialkanülen
Special Needles
Agujas especiales
Aiguilles spéciales
Aghi speciali

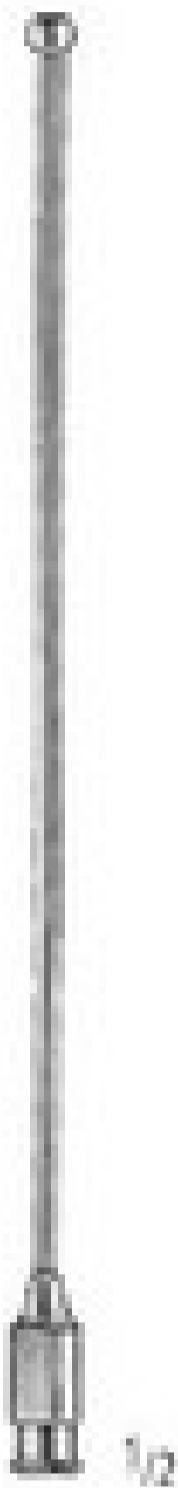

SCHMID

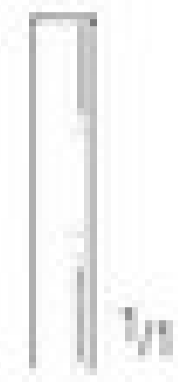

3,0 mm
AO 740/03

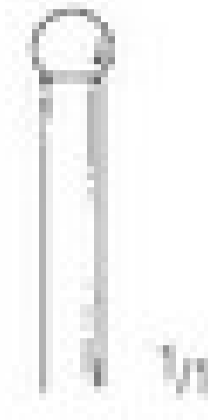

4,0 mm
AO 740/04

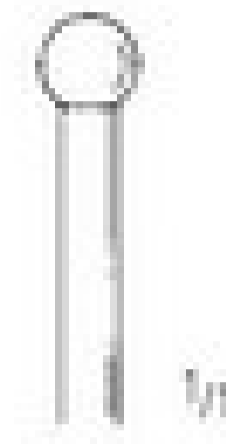

5,0 mm
AO 740/05

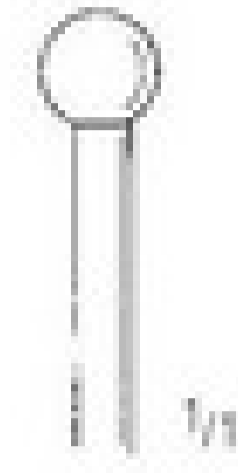

6,0 mm
AO 740/06

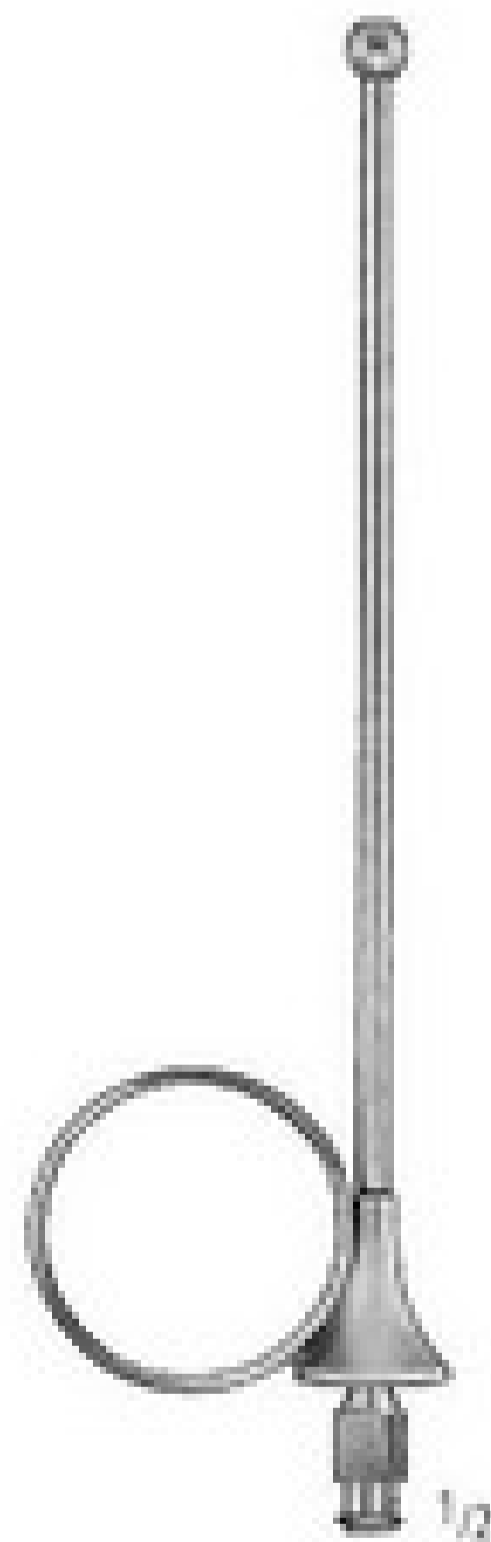

IOWA
AO 750/14
14,0 cm/5 1/2"

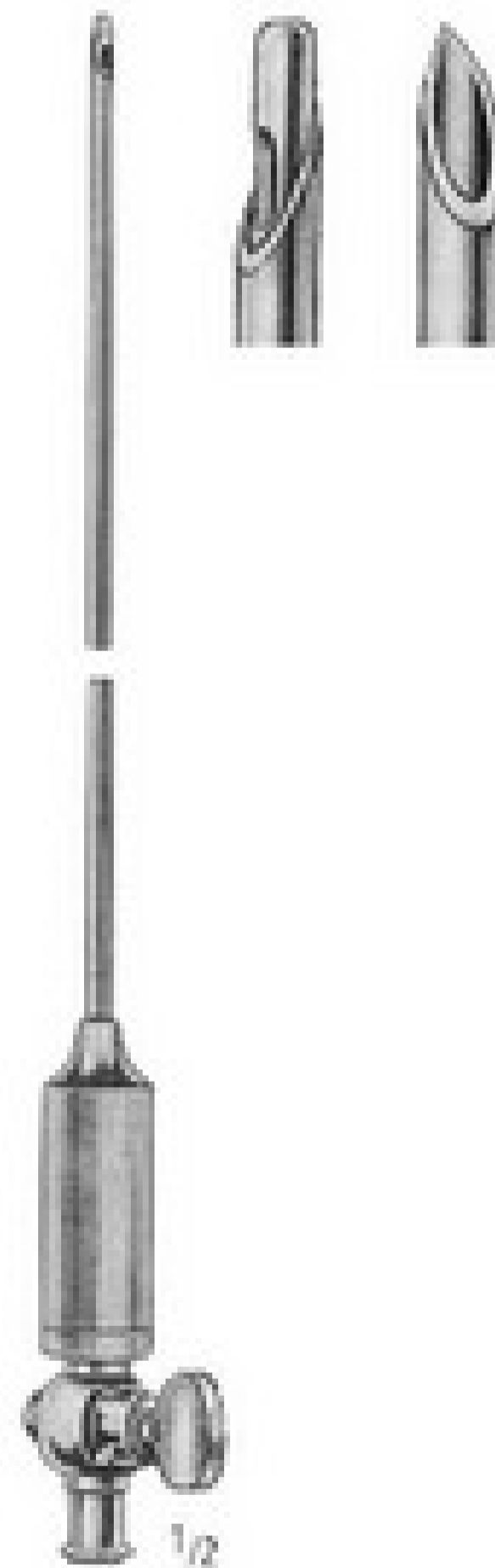

VERRES
1,55 x 55 mm AO 780/05
2,00 x 100 mm AO 780/10
2,00 x 120 mm AO 780/12
2,00 x 150 mm AO 780/15

Führungsnadeln
 Guide Needles
 Aguja de guía
 Aiguilles d'introduction
 Aghi per introduzione



Charr./Fr.

8 AO 820/08
 10 AO 820/10
 12 AO 820/12
 14 AO 820/14
 16 AO 820/16
 18 AO 820/18

AO 821/08
 AO 821/10
 AO 821/12
 AO 821/14
 AO 821/16
 AO 821/18

AO 822/08
 AO 822/10
 AO 822/12
 AO 822/14
 AO 822/16
 AO 822/18

AA
 AB
 AC
 AD
 AE
 AF
 AG
 AH
 AI
 AJ
 AK
 AL
 AM
AO
 AP
 AR

Spritzen
Syringes
Jeringas
Seringues
Siringhe



JANET

50 ml	AO 870/05
100 ml	AO 870/10
150 ml	AO 870/15
200 ml	AO 870/20



50 ml	AO 871/05
100 ml	AO 871/10
150 ml	AO 871/15
200 ml	AO 871/20

Hähne und Verbindungsstücke
 Stopcocks and Connecting Pieces
 Llaves y Piezas de conexión
 Robinets et Raccords
 Rubinetti e Raccordi

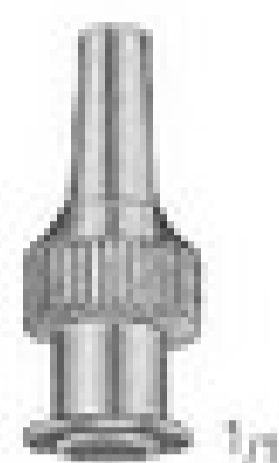

AO 910/00

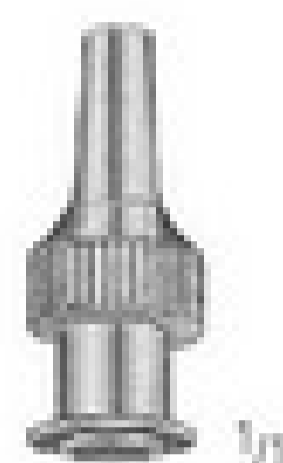

AO 911/00

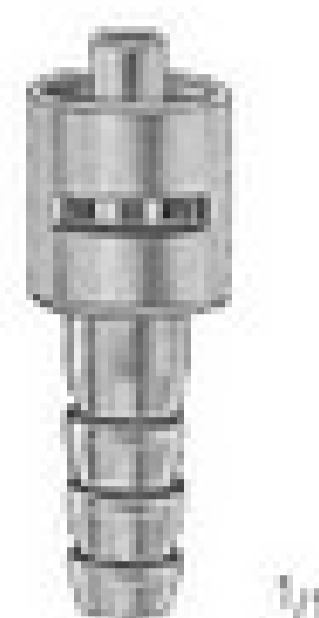

AO 912/00

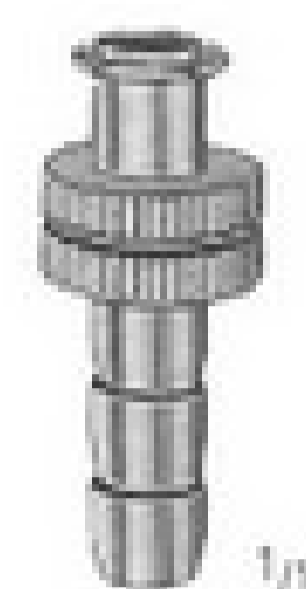

AO 913/00

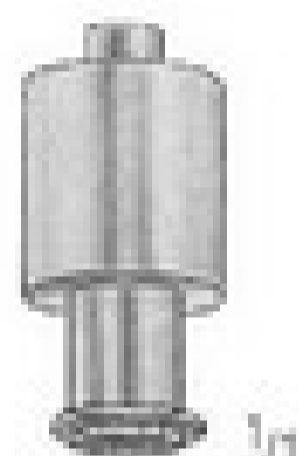

AO 914/00

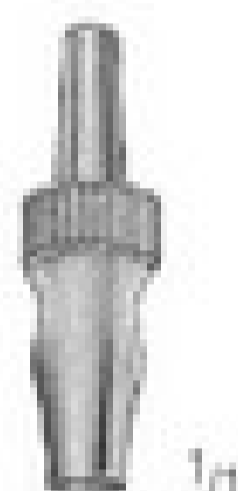

AO 915/00

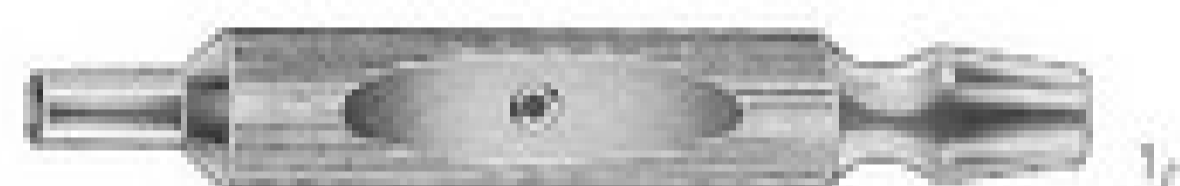

AO 916/00

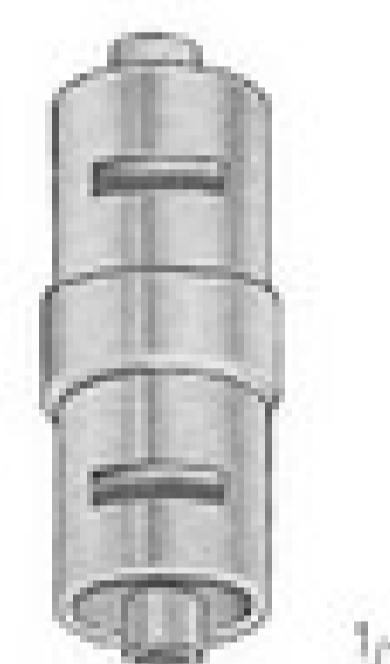

AO 917/00

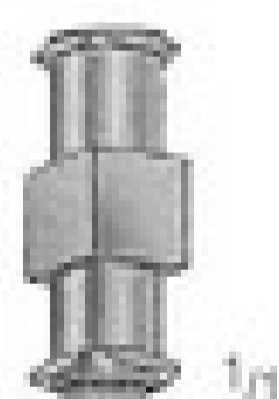

AO 918/00



AO 920/00

links
 left
 izquierda
 gauche
 sinistra

AO 921/01



rechts
 right
 derecha
 droite
 destra

AO 921/02



AO 922/00



AO 923/00



AO 924/00

AA

AB

AC

AD

AE

AF

AK

AL

AM

AO

AP

AR