UROLOGIE
UROLOGY
UROLOGIA
UROLOGIE
UROLOGIA

KC

nopa[®] instruments



UROLOGIE UROLOGY UROLOGIA UROLOGIE UROLOGIA

Nierensteinzangen
 Kidney Stone Forceps
 Pinzas para cálculos renales
 Pincers pour les calculs du bassinet
 Pinza per calcoli renali

KA

KB

KC

KD

KK

KL

KM

KO

KP

KU

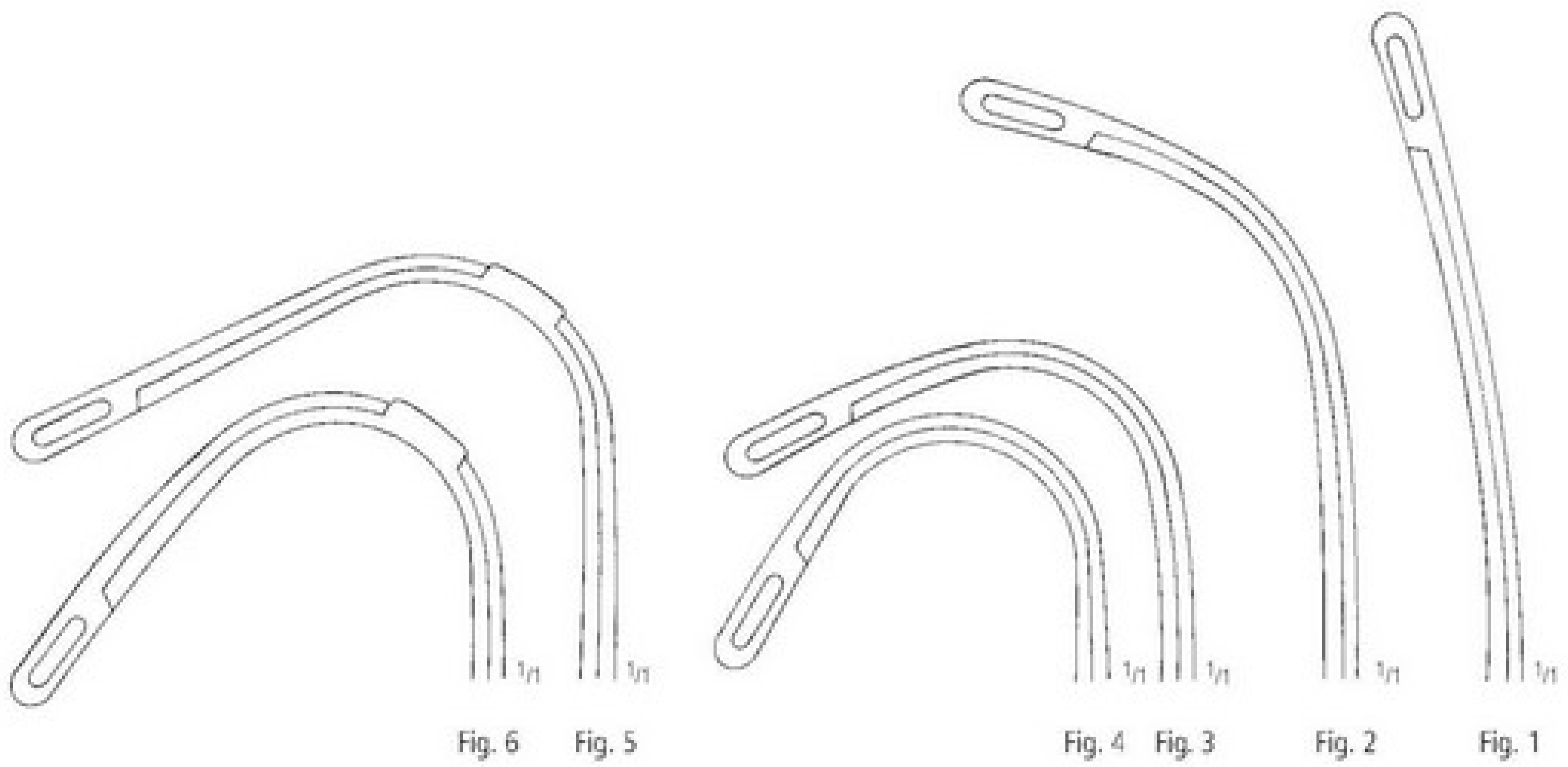

Fig.	cm / in.	RANDALL
1	23,0/9"	KC 051/01
2	22,0/8 ³ / ₄ "	KC 051/02
3	22,0/8 ³ / ₄ "	KC 051/03
4	22,0/8 ³ / ₄ "	KC 051/04
5	19,0/7 ¹ / ₂ "	KC 051/05
6	19,0/7 ¹ / ₂ "	KC 051/06

Tangentialklemmen
 Tangential Forceps
 Pinzas tangenciales
 Pincas à tangential
 Pinze per tangentiale



URO-TANGENTIAL
 26,0 cm/10¹/₄"



KC 055/01



KC 055/02



1/2

UROLOGIE UROLOGY UROLOGIA UROLOGIE UROLOGIA

Gallensteinsonden, Gallenkanal Dilatatoren
 Gall Stone Probes, Gall Duct Dilators
 Exploradores para cálculos biliares, Dilatadores para conductos biliares
 Explorateurs à calculs biliaires, Dilatateurs à voies biliaires
 Sonde per calcoli biliari, Dilatatori per condotti biliari

KA
 KB
KC
 KD
 KE
 KF
 KG
 KH
 KI
 KJ
 KK
 KL
 KM
 KN
 KO
 KP
 KQ
 KR
 KS
 KT
 KU

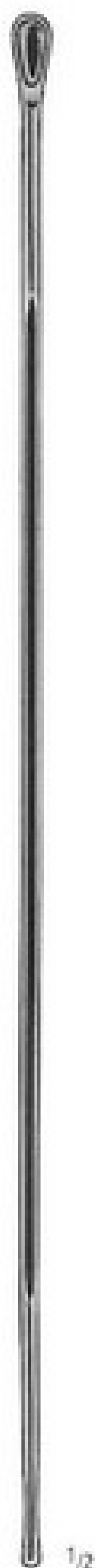

MOYNIHAN
 KC 110/34
 34,0 cm/13 1/2"

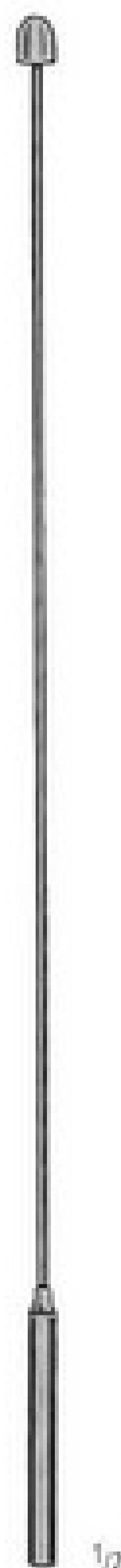

DESJARDINS
 28,0 cm/11"



KC 120/02

KC 120/04

KC 120/06

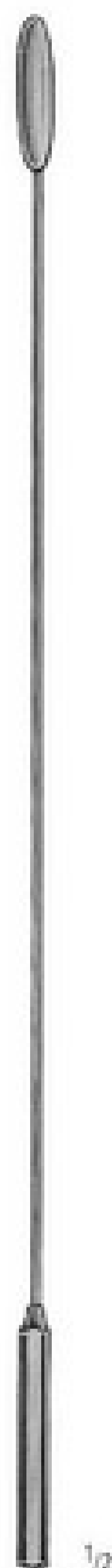

BAKES
 30,0 cm/12"

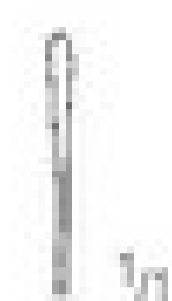

Fig. 1
 KC 130/01

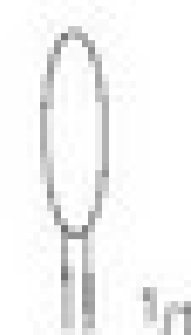

Fig. 2
 KC 130/02

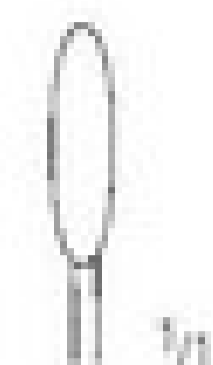

Fig. 3
 KC 130/03

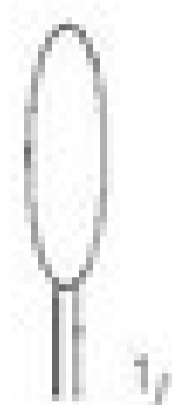

Fig. 4
 KC 130/04

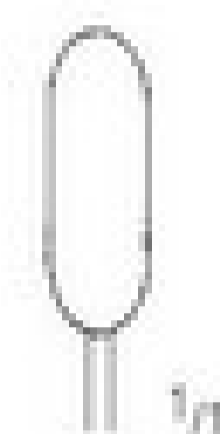

Fig. 5
 KC 130/05

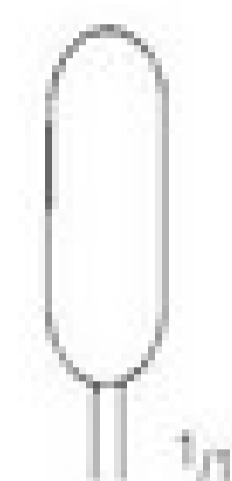

Fig. 6
 KC 130/06

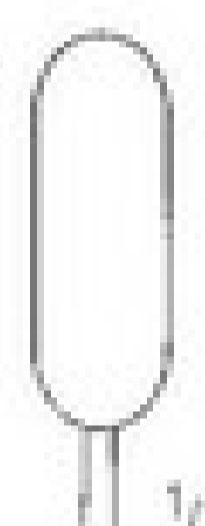

Fig. 7
 KC 130/07

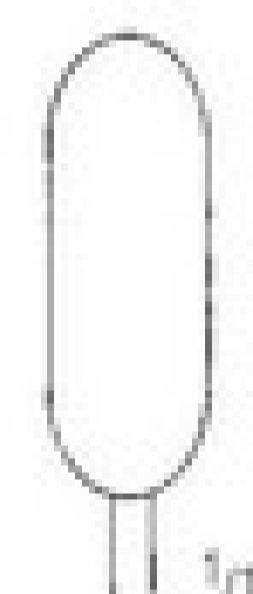

Fig. 8
 KC 130/08

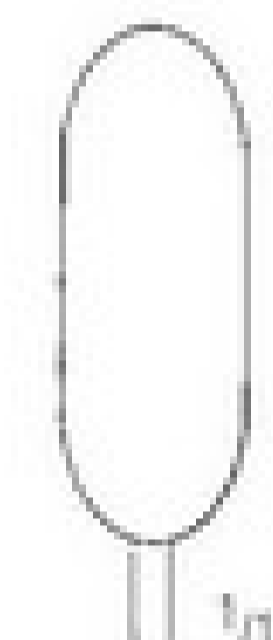

Fig. 9
 KC 130/09

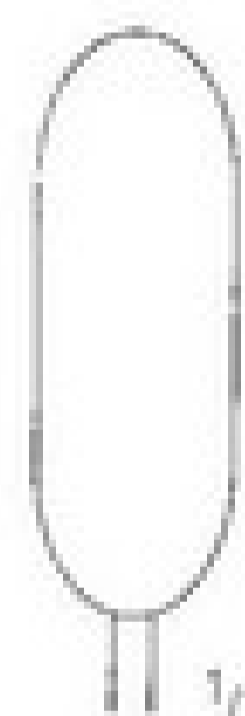

Fig. 10
 KC 130/10

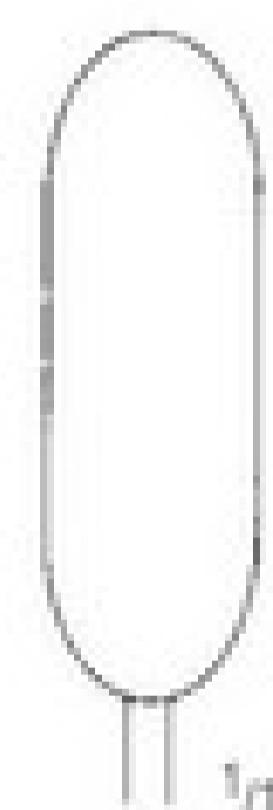

Fig. 11
 KC 130/11



Fig. 12
 KC 130/12

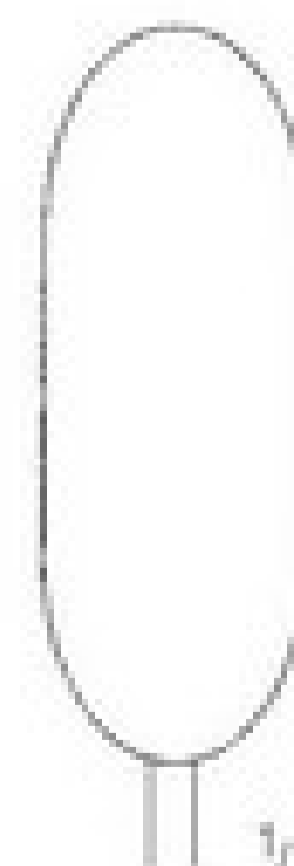

Fig. 13
 KC 130/13

Gallensteinzangen
 Gall Stone Forceps
 Pinzas para cálculos biliares
 Pincès pour calculs biliaires
 Pinze per calcoli biliari



BLAKE
 KC 186/20
 20,0 cm/8"

BLAKE
 KC 187/20
 20,0 cm/8"

MAYO-BLAKE
 KC 188/20
 20,0 cm/8"

MAYO-BLAKE
 KC 189/20
 20,0 cm/8"

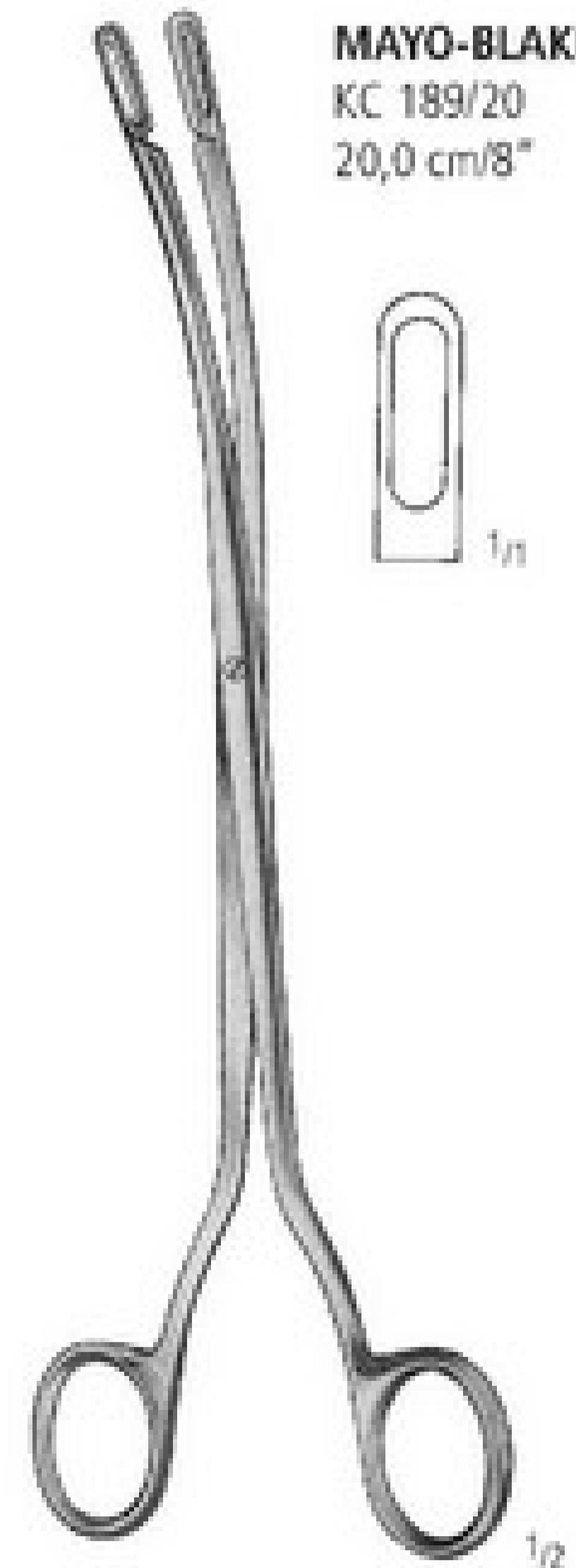
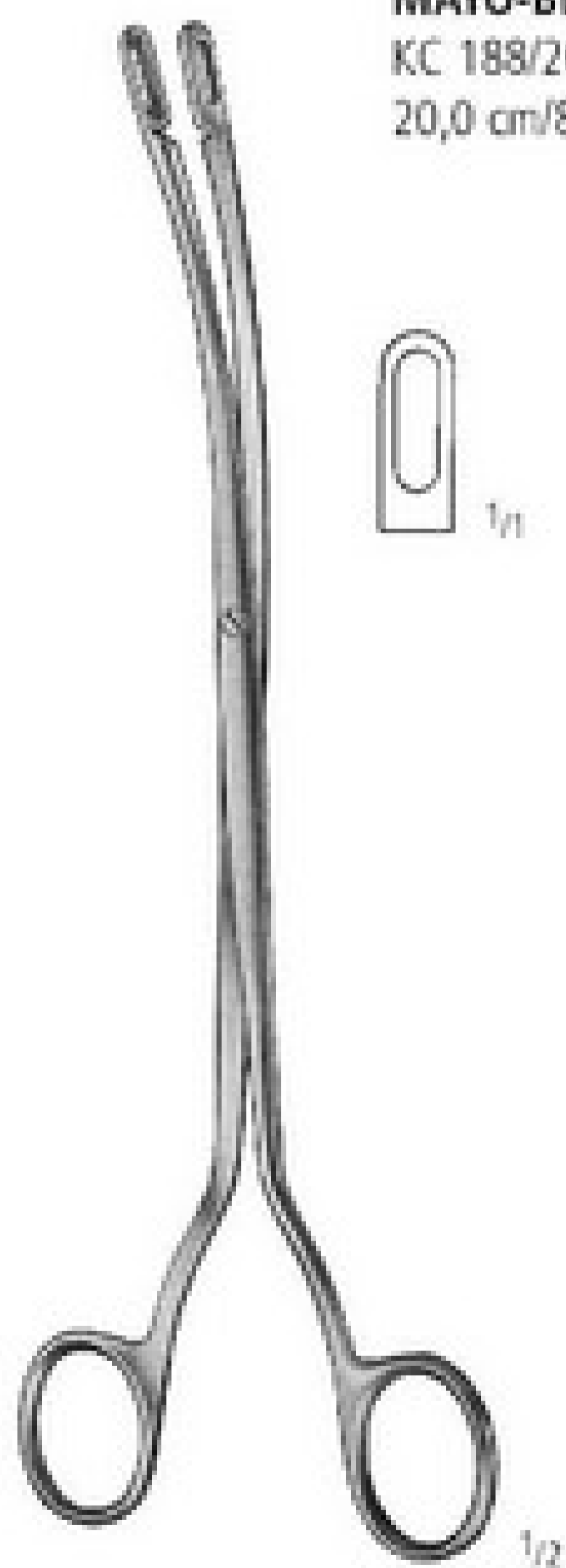
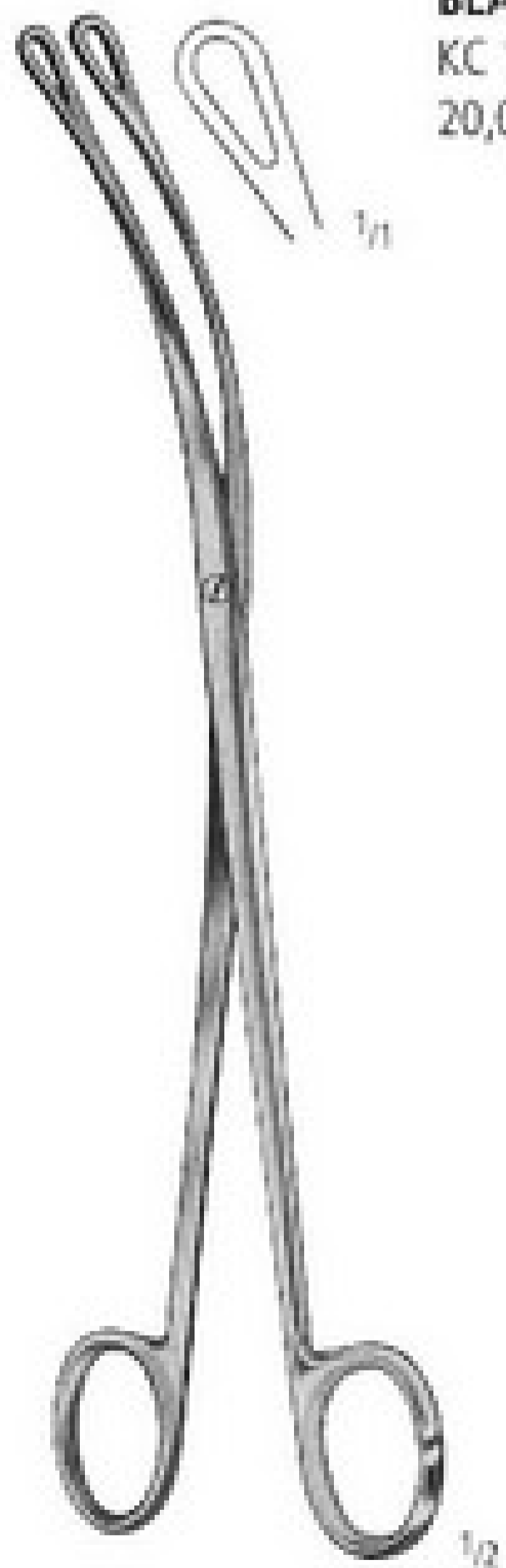

MIXTER
 KC 190/22
 22,0 cm/8³/₄"

DESJARDINS
 KC 191/01
 23,0 cm/9"

DESJARDINS
 KC 191/02
 23,0 cm/9"

UROLOGIE UROLOGY UROLOGIA UROLOGIE UROLOGIA

Gallensteinöffel
 Gall Stone Scoops
 Cucharillas para coger cálculos biliares
 Curettes pour calculs biliaires
 Cucchiari per calcoli biliari

KA

KB

KC

KD

KK

KL

KM

KO

KP

KU



KC 200/01

KC 200/02

KC 200/03

KC 200/04

DESJARDINS
 30,0 cm/12"



LUER-KOERTE
 32,0 cm/12³/₄"

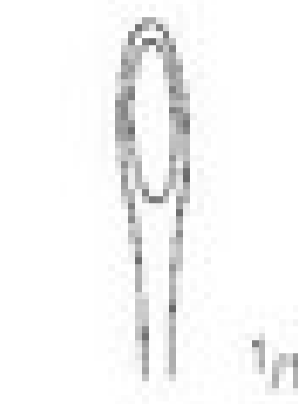

2,5 mm
 Fig. 000
 KC 210/02

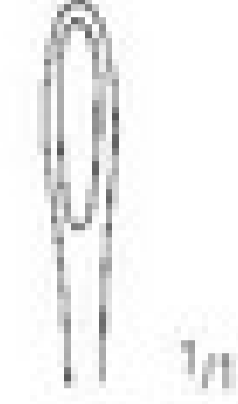

3,2 mm
 Fig. 00
 KC 210/03

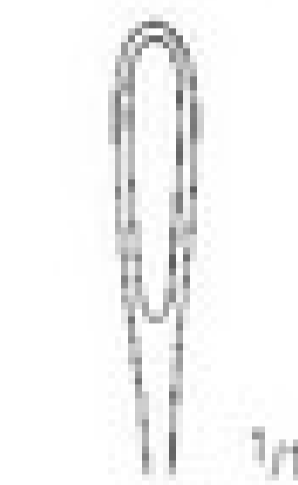

4,2 mm
 Fig. 0
 KC 210/04

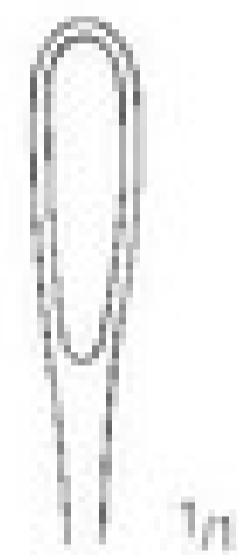

5,5 mm
 Fig. 1
 KC 210/05

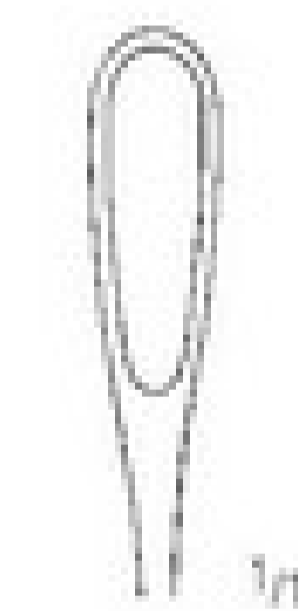

6,7 mm
 Fig. 2
 KC 210/06



8,0 mm
 Fig. 3
 KC 210/08

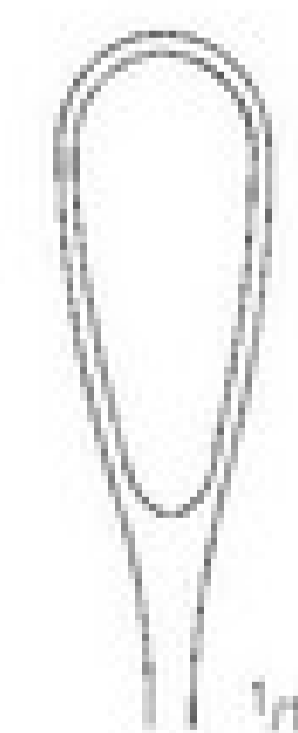

11,0 mm
 Fig. 4
 KC 210/11



15,0 mm
 Fig. 5
 KC 210/15

Prostatahaken
 Prostatic Retractors
 Separadores para la próstata
 Ecarteurs prostatiques
 Divanicatori prostatici

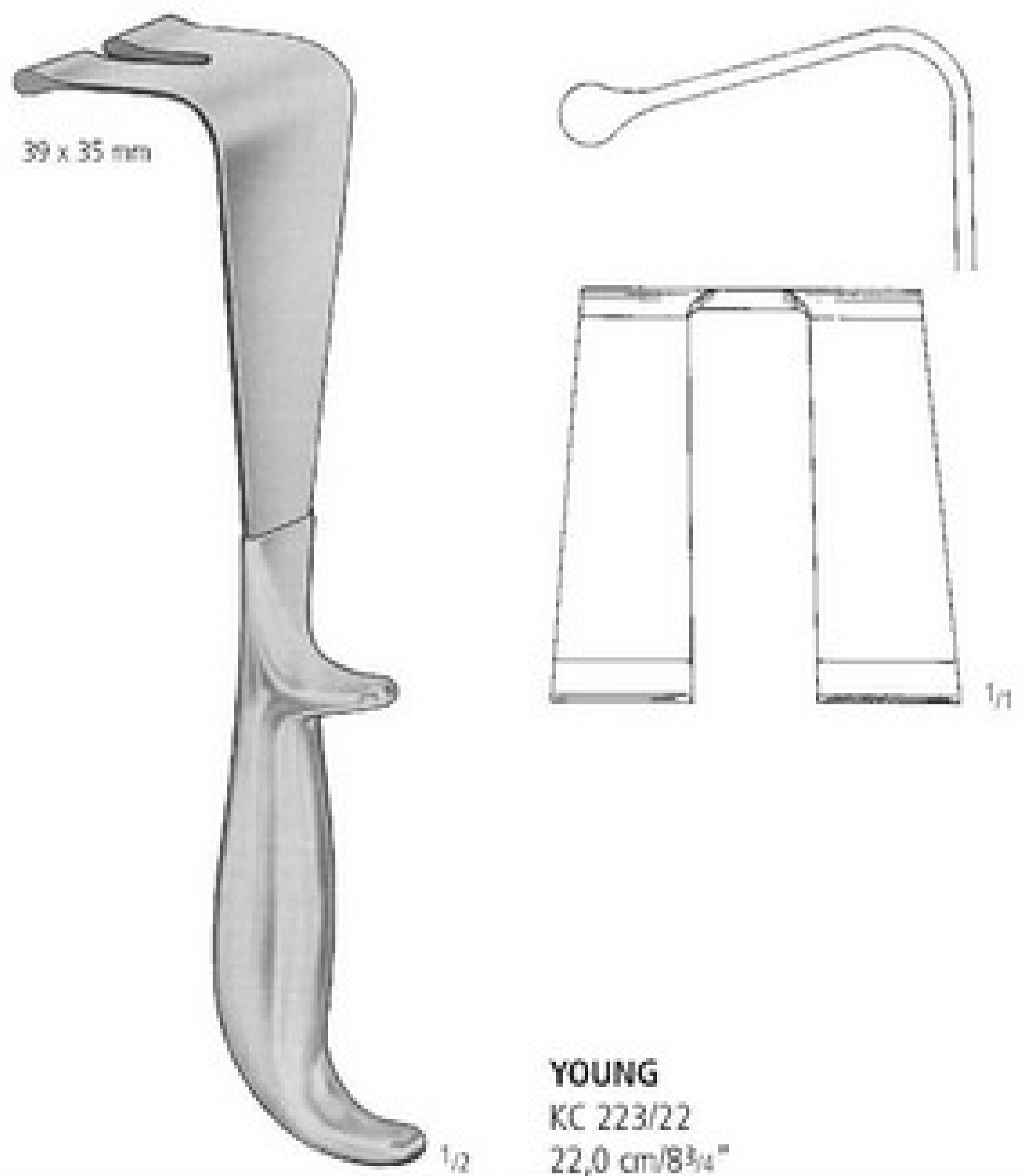
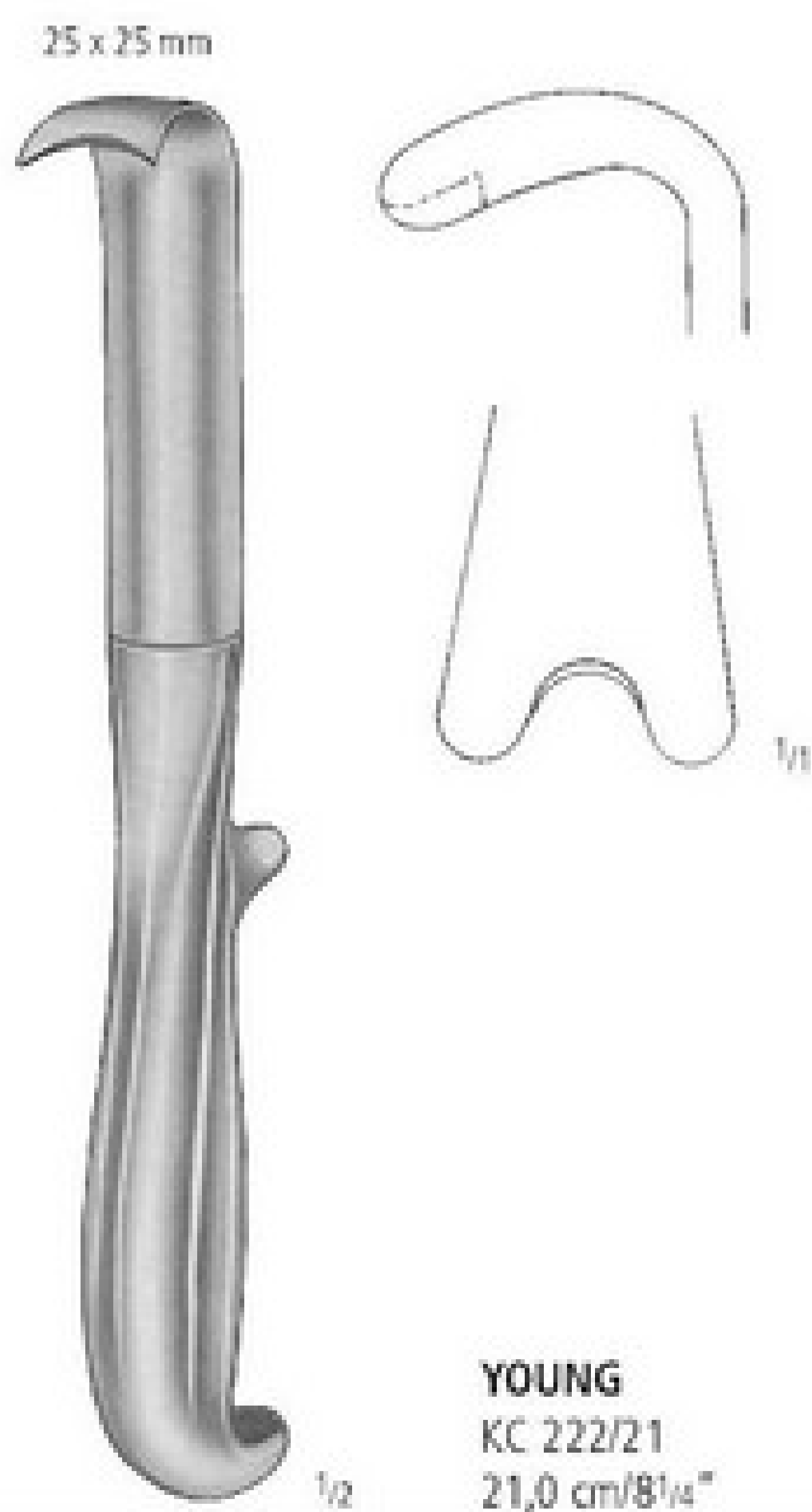
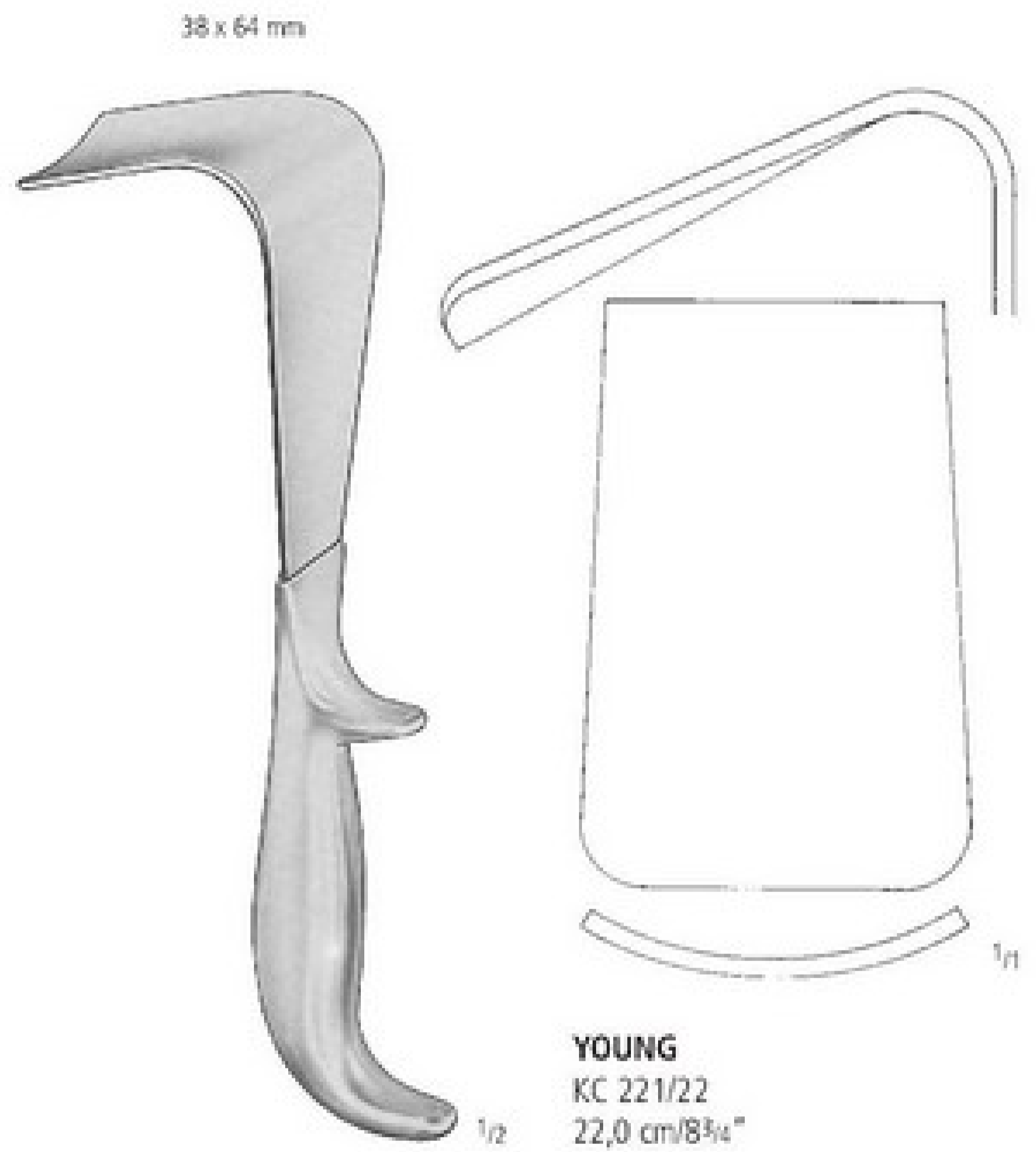
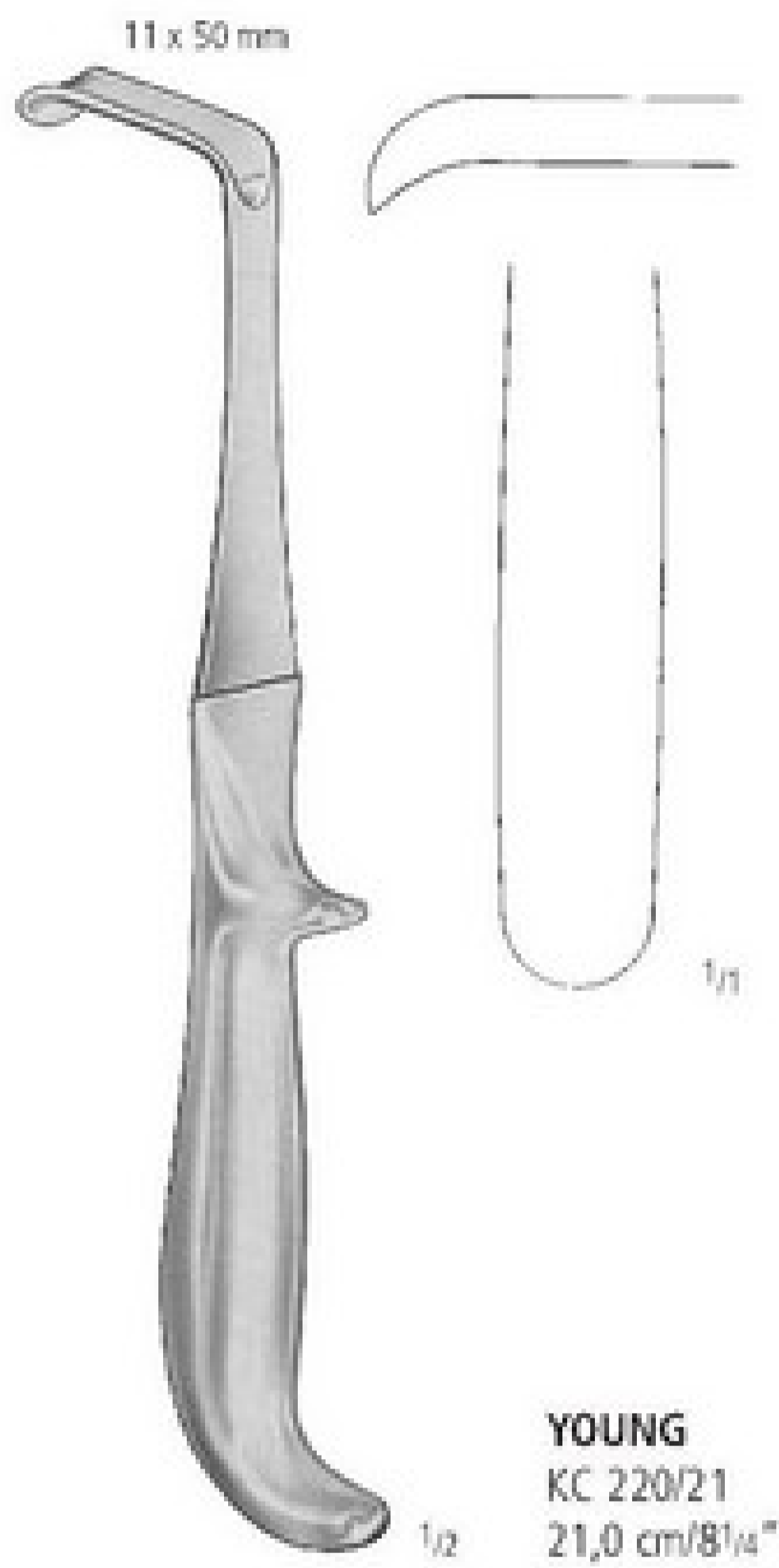

Instrumente für Prostata-Operationen
 Prostatectomy Instruments
 Instrumentos para prostatectomía
 Instruments pour prostatectomie
 Strumenti per operazioni della prostata

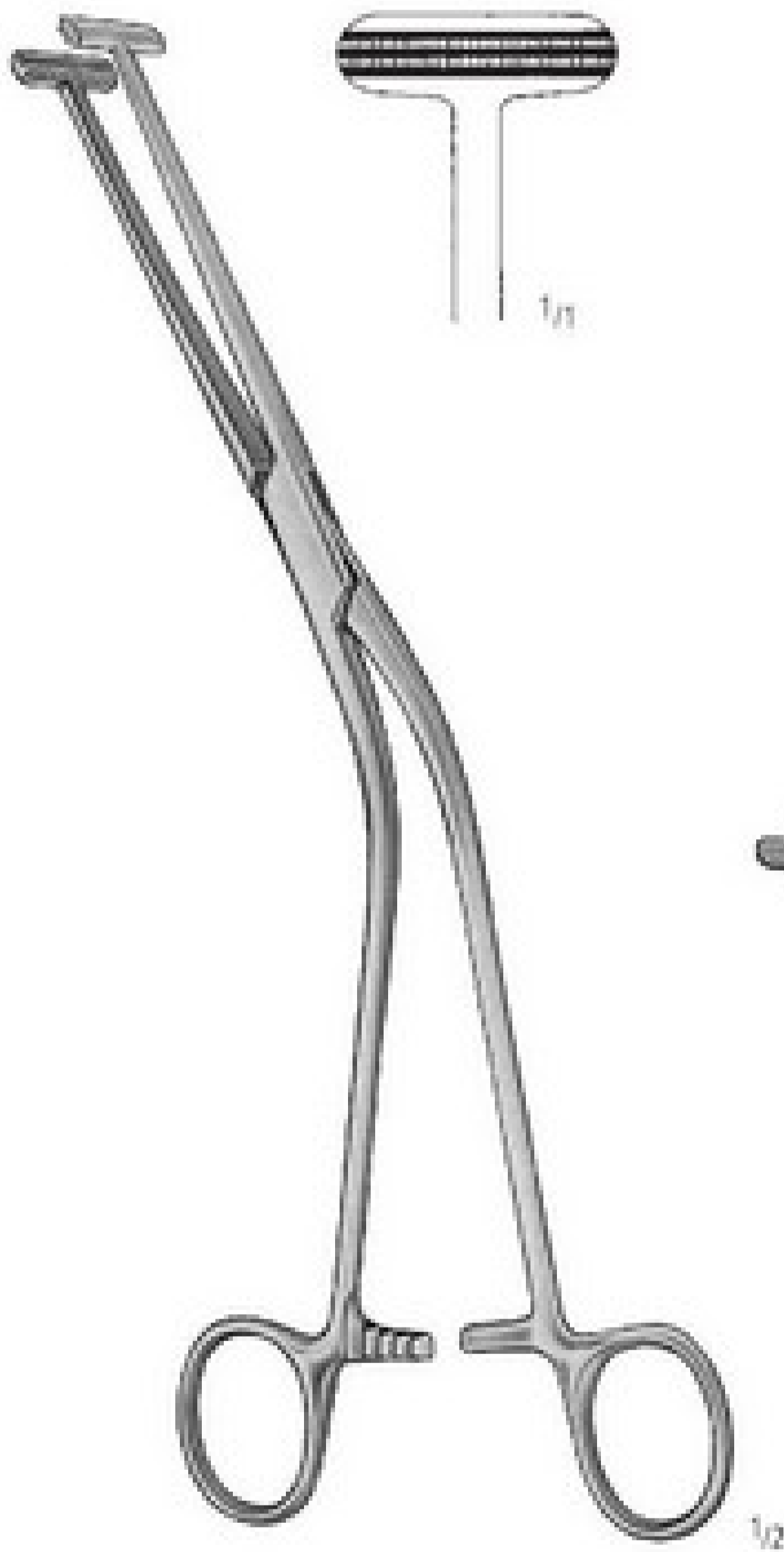

MILLIN
 KC 231/24
 24,0 cm/9 1/2"

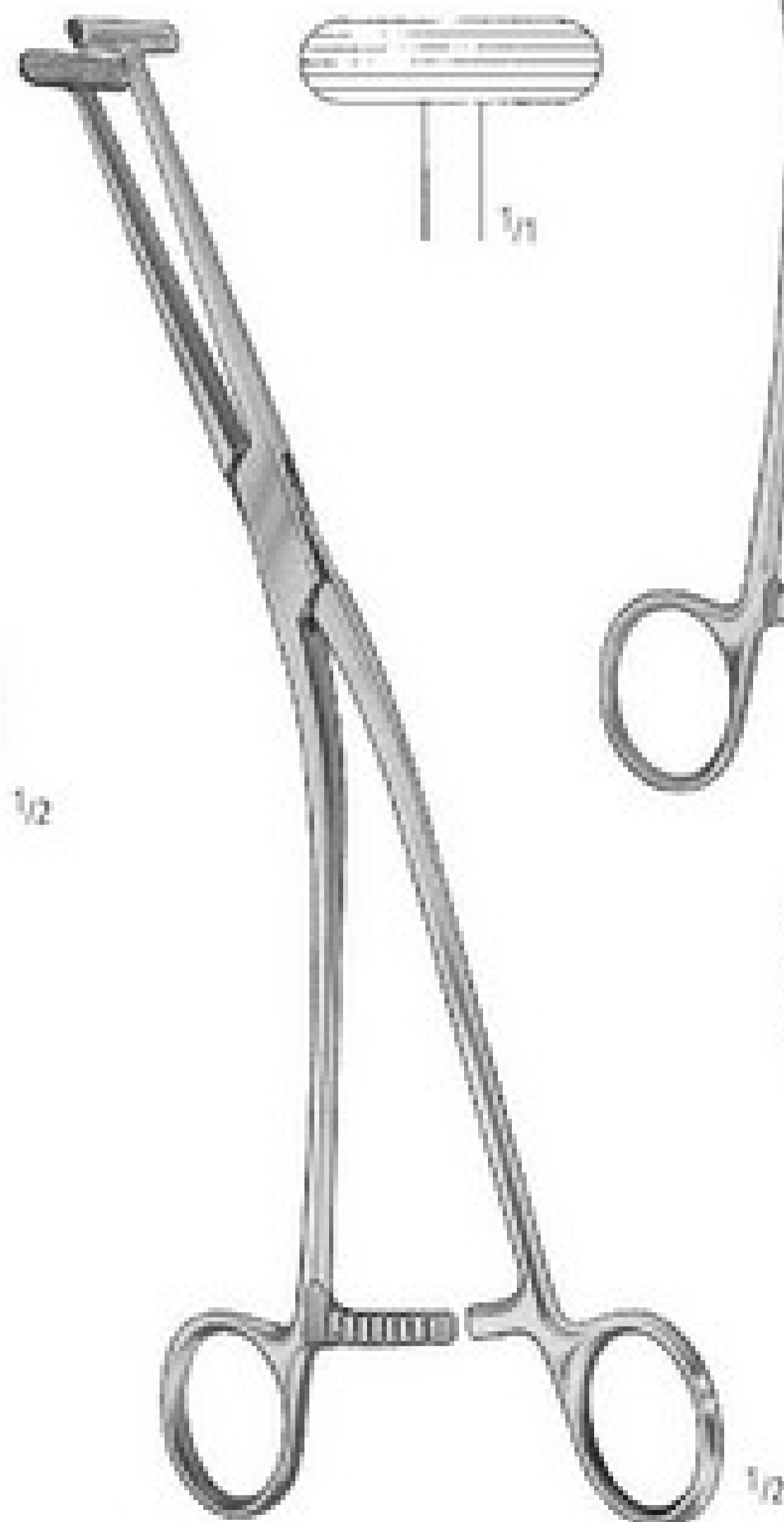

MILLIN
 KC 241/01
 23,0 cm/9"

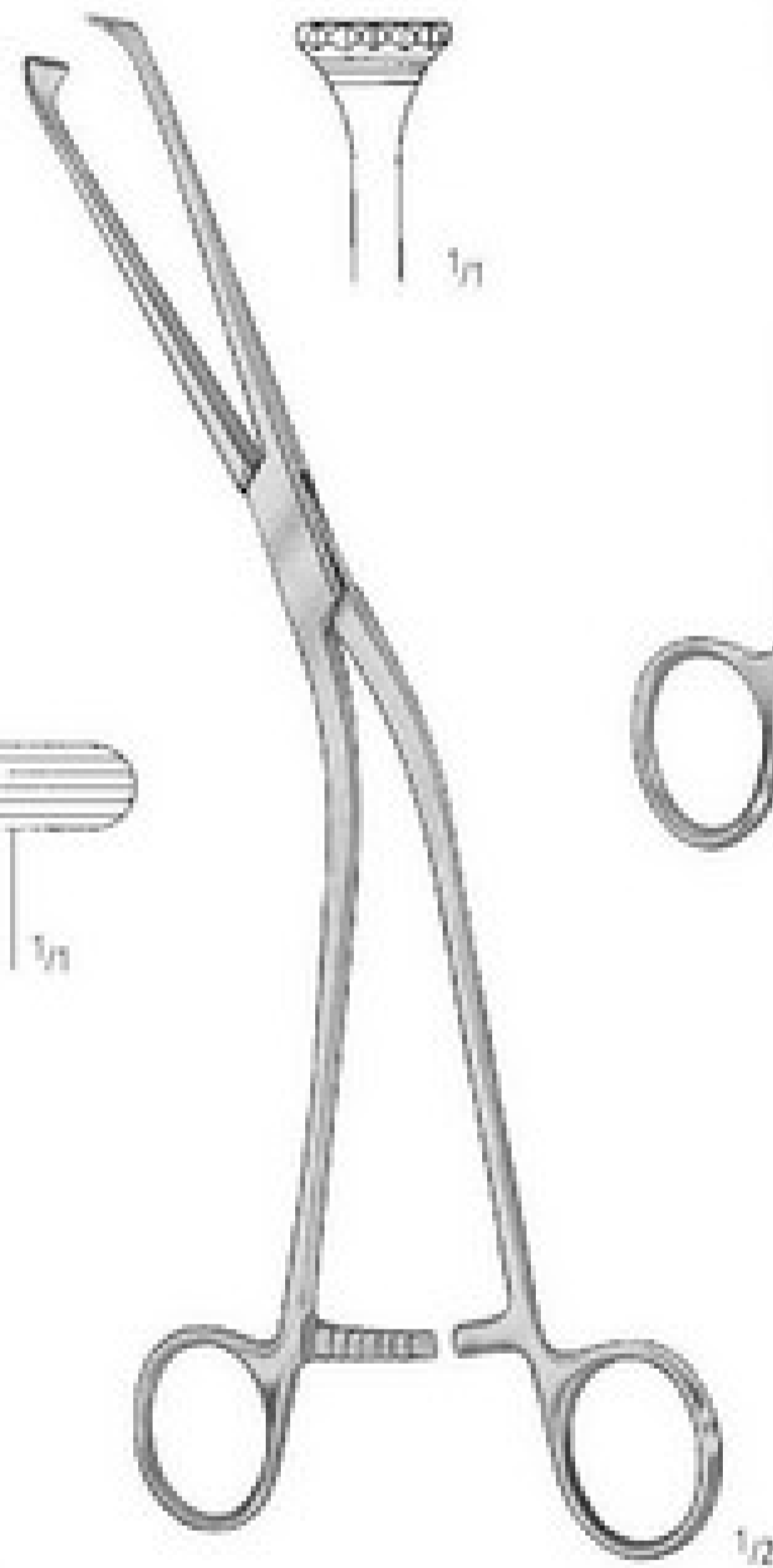

MILLIN
 KC 241/02
 23,0 cm/9"

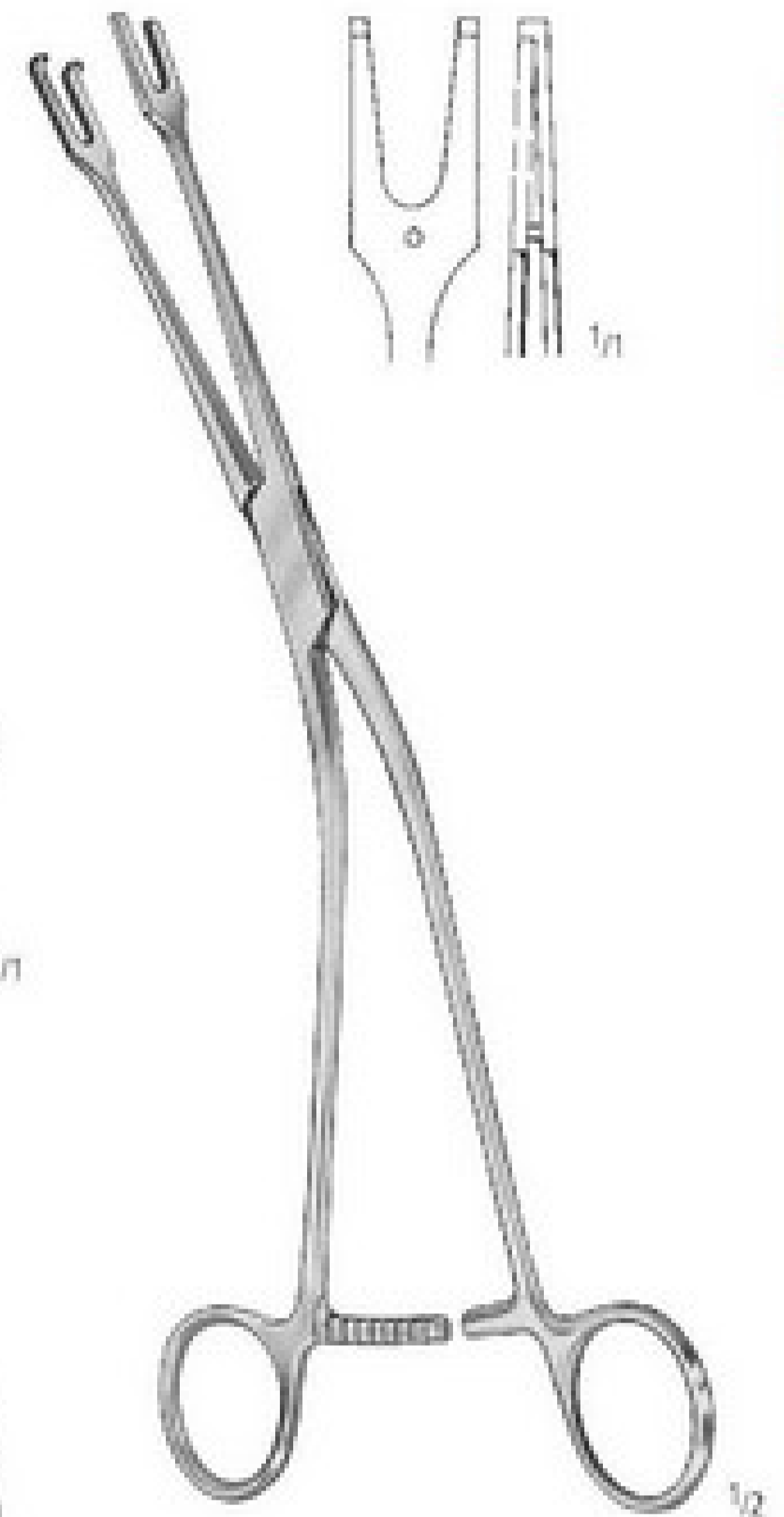

MILLIN
 KC 241/03
 24,0 cm/9 1/2"

KA
 KB
KC
 KD
 KE
 KF
 KG
 KH
 KI
 KJ
 KK
 KL
 KM
 KN
 KO
 KP
 KQ
 KR
 KS
 KT
 KU

Urethrotom
 Urethrotome
 Uretrótomos
 Uréthrotomes
 Uretrotomi

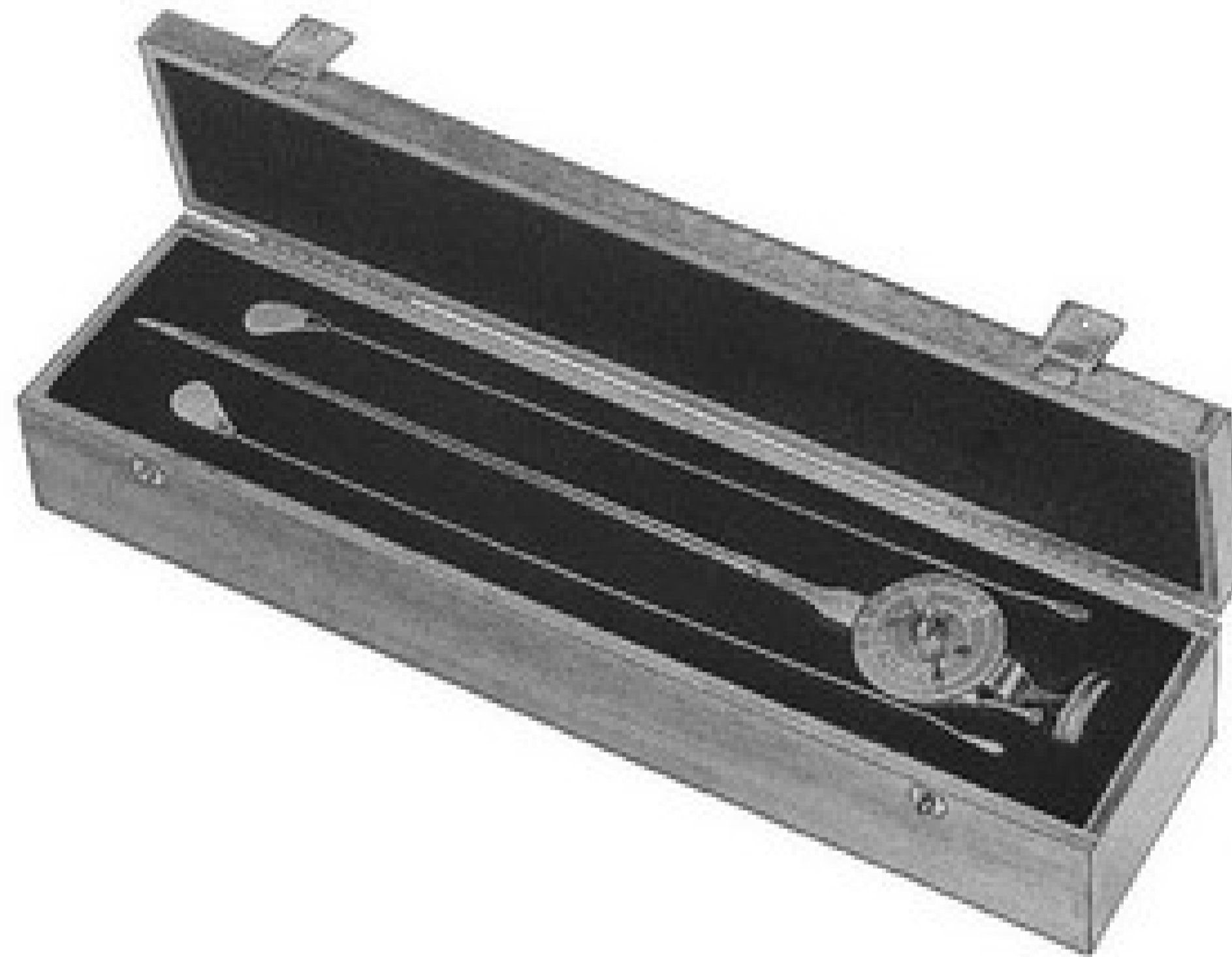

OTIS
 KC 246/00

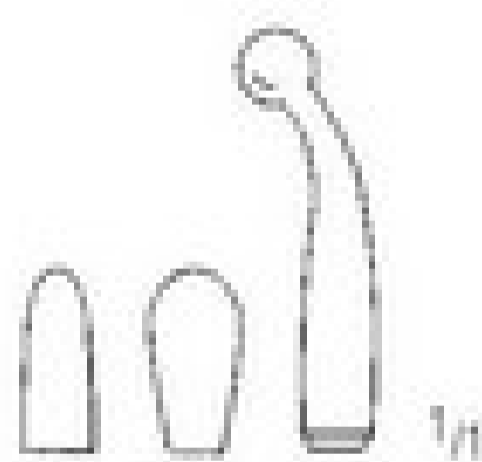
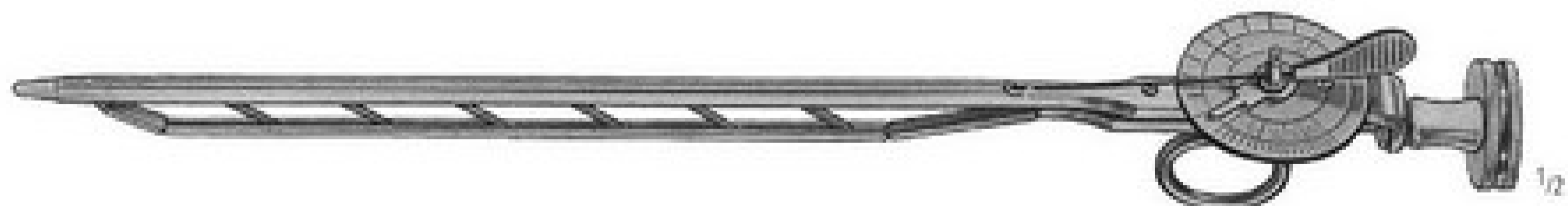

komplett
 complete
 completo
 complet
 completo

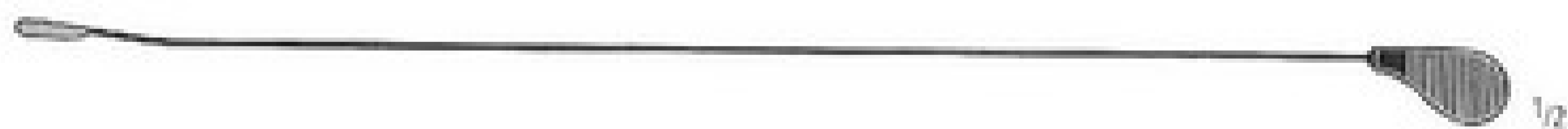

KC 246/10

Blasen-Wundspreizer
 Bladder Retractors
 Separadores vesicales
 Ecarteurs vésicaux
 Divanicatori vescicali

KA

KB

KC

KD

KK

KL

KM

KO

KP

KU



MILLIN
 KC 310/00
 28,0 cm/11"



LEGUEU
 KC 320/00
 17,0 cm/6 1/2"

Blasen-Wundspreizer
 Bladder Retractors
 Separadores vesicales
 Ecarteurs vésicaux
 Divaricatori vescicali

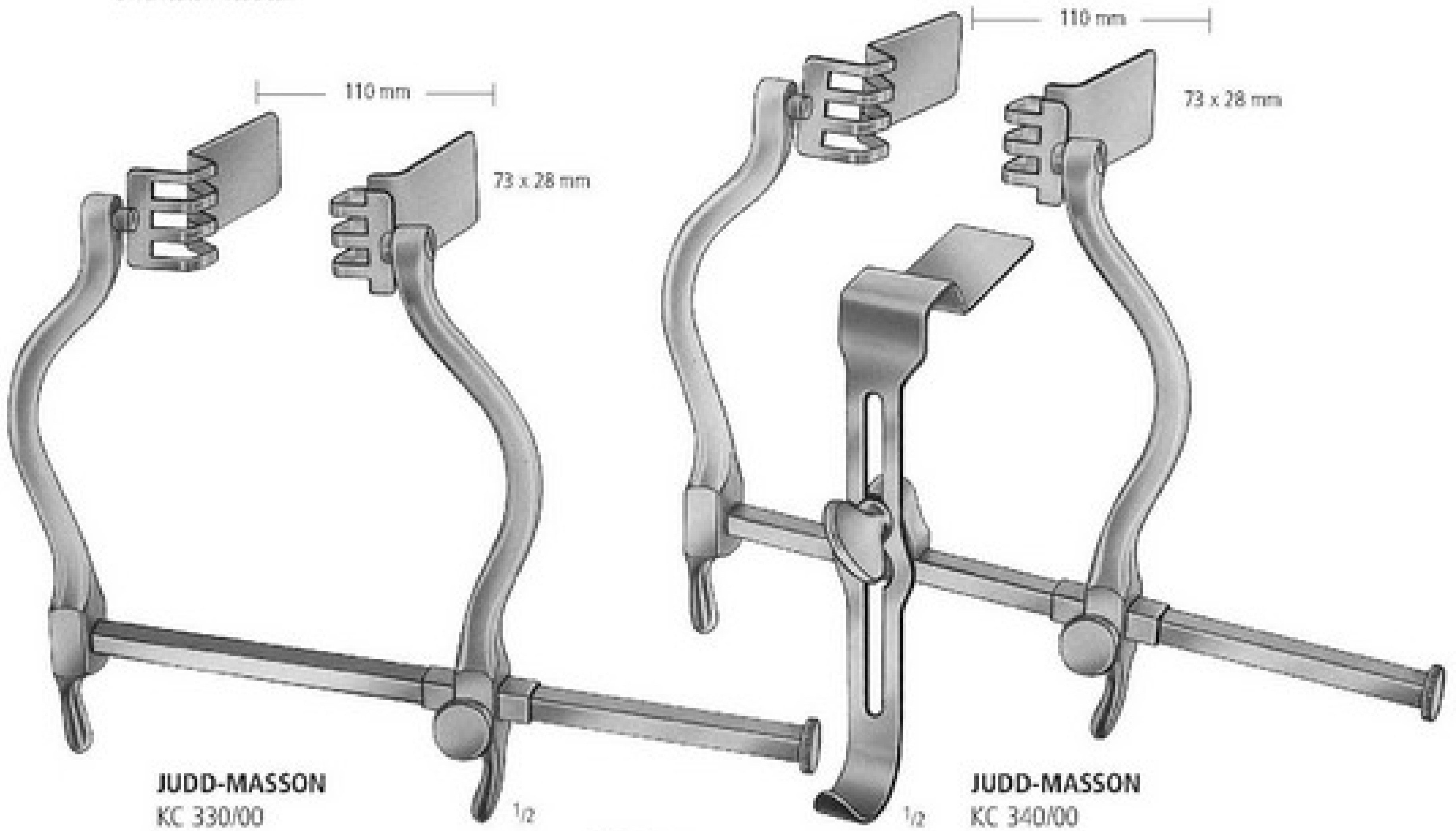

JUDD-MASSON
 KC 330/00

JUDD-MASSON
 KC 340/00

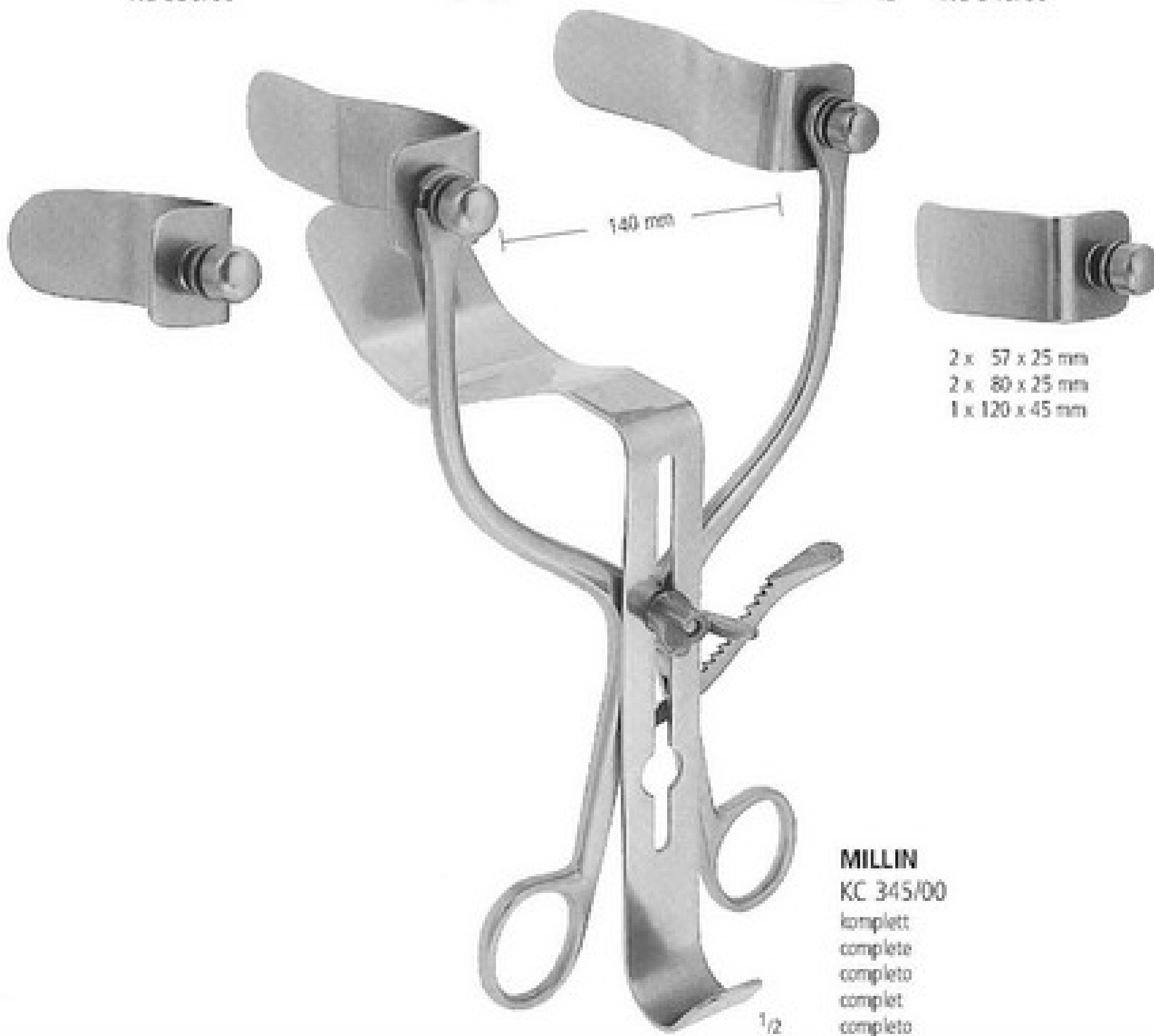

MILLIN
 KC 345/00
 komplett
 complete
 completo
 complet
 completo

Blasenspatel
 Bladder Retractors
 Separadores vesicales
 Spatules et Valves vésicales
 Spatole e Divaricatori vescicali

KA

KB

KC

KD

KE

KL

KM

KO

KP

KU

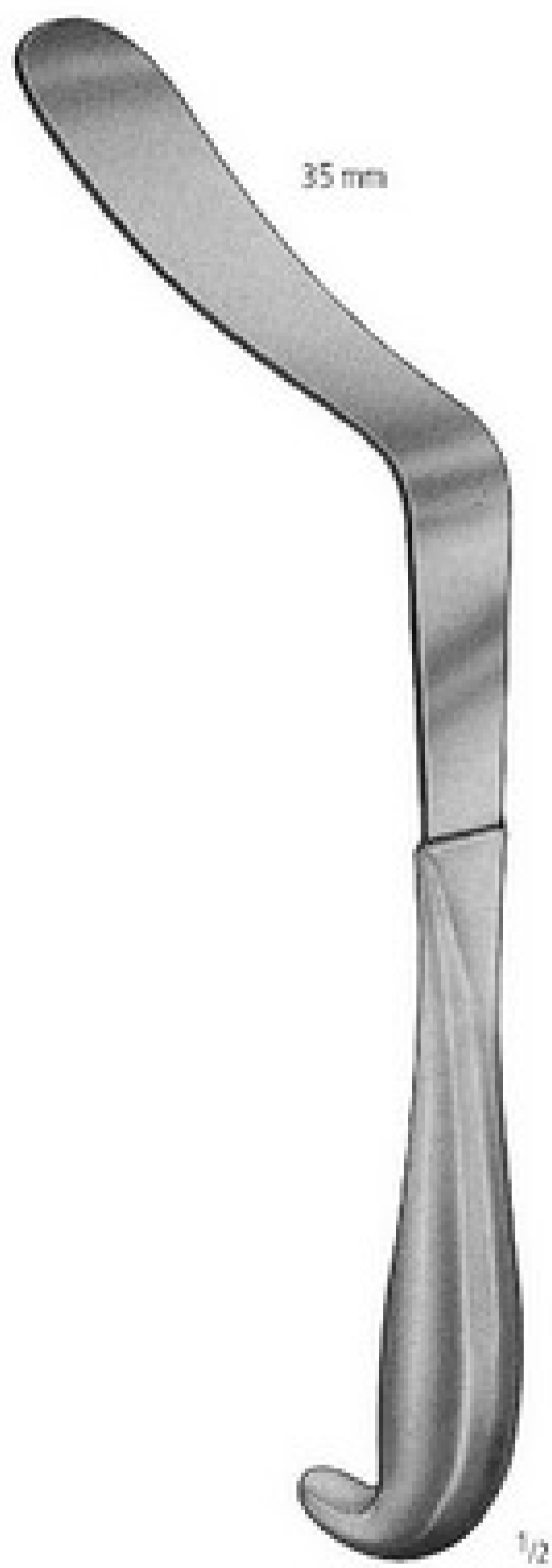

LEGUEU
 KC 350/27
 27,0 cm/10¹/₂"



KOCHER
 KC 357/26
 26,0 cm/10¹/₄"

Einführungsinstrumente
 Catheter Introducing Instruments
 Instrumentos para introducir catéteres
 Mandrins pour sondes urétrales
 Mandrini per sonda uretali



MATHIEU
 KC 420/20 20,0 cm/8"
 KC 420/28 28,0 cm/11"

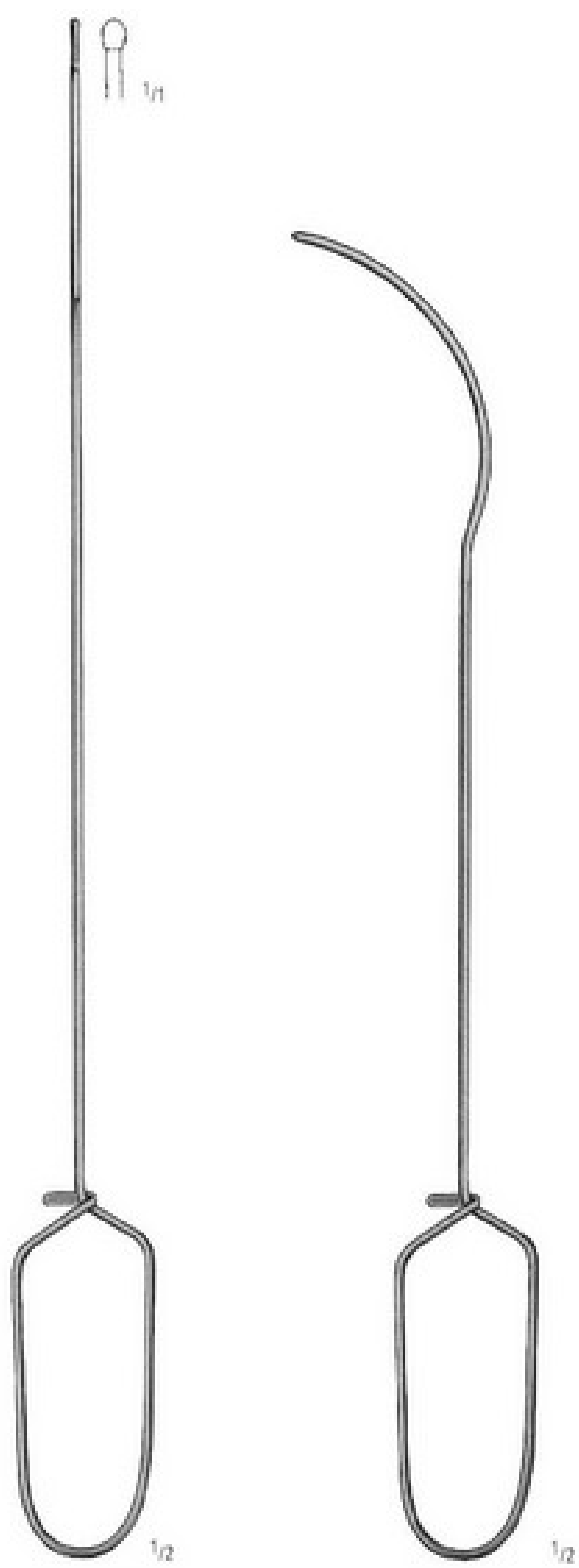

GUYON
 KC 406/39
 39,0 cm/15 1/2"

GUYON
 KC 407/35
 35,0 cm/13 3/4"

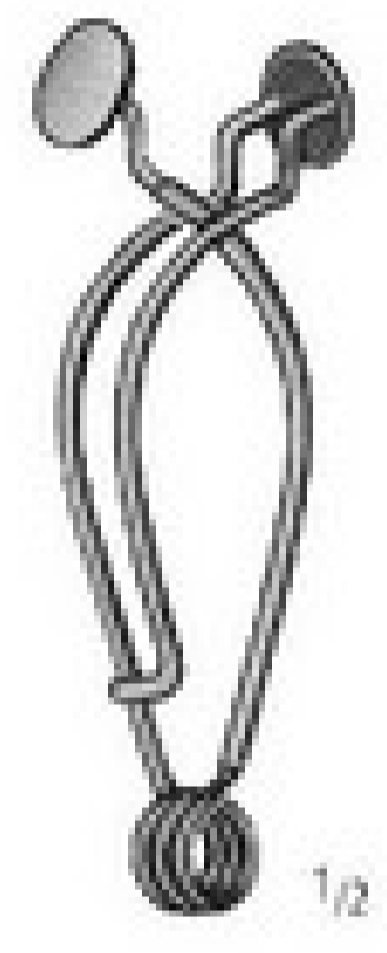

STOCKMANN
 KC 445/08
 8,0 cm/3"

Penisklemmen
 Penis Seizing Forceps
 Compresseur de l'urètre
 Compresores uretrales
 Serrapene

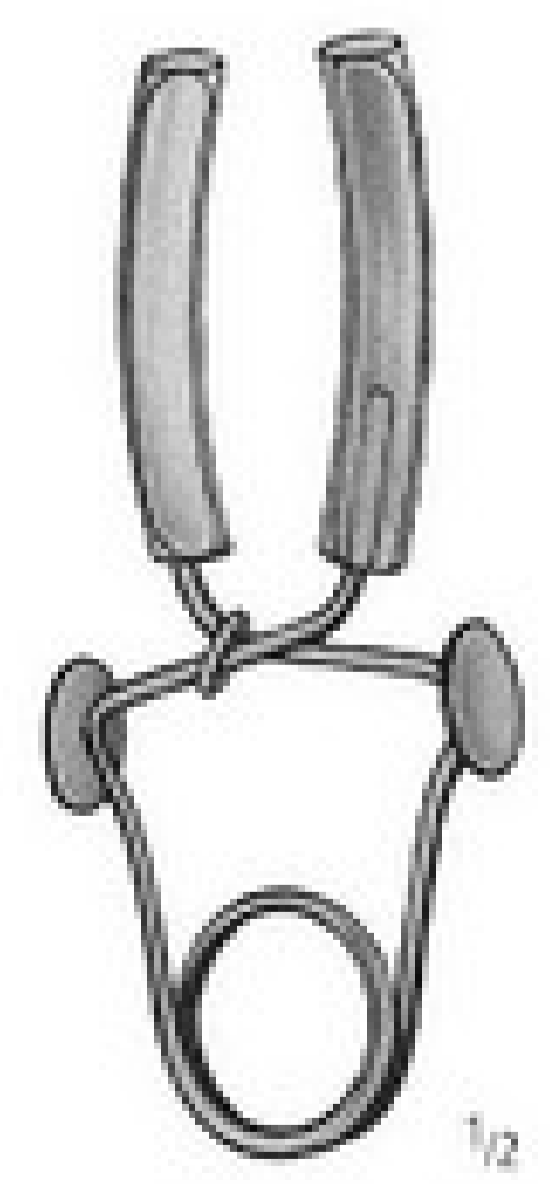

STRAUSS
 KC 449/11
 11,0 cm/4 1/3"

Beschneidungsinstrument
Circumcision Instrument
Instrumento de circuncisión
Instrument de circoncision
Strumenti per circuncisione

KA

KB

KC

KD

KK

KL

KM

KO

KP

KU



KNUTSON Urethrographie - Instrument
KC 520/00
18,0 cm/7"

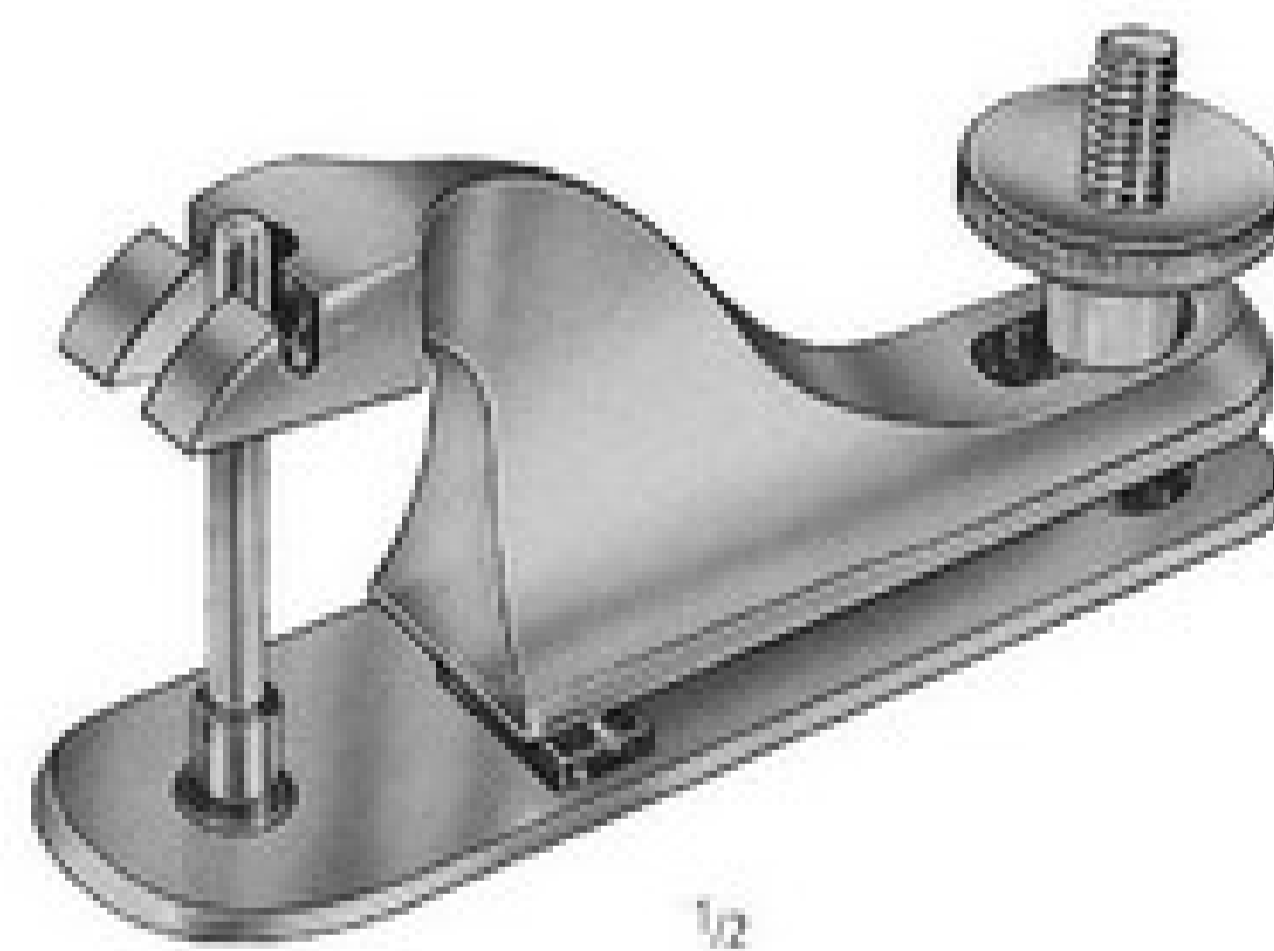

KC 530/08 - KC 530/32

mm Ø	
8	KC 530/08
11	KC 530/11
13	KC 530/13
16	KC 530/16
21	KC 530/21
26	KC 530/26
32	KC 530/32

Dilatationsbesteck
 Set of Dilating Sounds
 Juego de bujías dilatadoras
 Trousse de cathéters dilatateurs
 Set di candelette dilatatrici



GUYON
 KC 700/00
 420 x 175 x 40 mm

Besteck in Metalletui bestehend aus:
 21 Bougies Guyon
 4 Gleitsonden

Set in metal case containing:
 21 Bougies Guyon
 4 filiform Bougies

Juego en estuche de metal, conteniendo:
 21 bujías Guyon
 4 bujías conductoras

Trousse en boîte métal, contenant:
 21 bougies Guyon
 4 bougies conductrices

Set in scatola metallica, contenente:
 21 candelette Guyon
 4 candelette filiformi

Dilationsbougies
 Dilating Bougies
 Bujías dilatadoras
 Bougies dilatatrices
 Candelette dilatatrici

KA

KB

KC

KD

KK

KL

KM

KO

KP

KU

mm Ø	charrière (french)	GUYON	VAN BUREN
2 ² / ₃	8		KC 720/08
3 ¹ / ₃	10	KC 710/10	KC 720/10
3 ² / ₃	11	KC 710/11	
4	12	KC 710/12	KC 720/12
4 ¹ / ₃	13	KC 710/13	
4 ² / ₃	14	KC 710/14	KC 720/14
5	15	KC 710/15	
5 ¹ / ₃	16	KC 710/16	KC 720/16
5 ² / ₃	17	KC 710/17	
6	18	KC 710/18	KC 720/18
6 ¹ / ₃	19	KC 710/19	
6 ² / ₃	20	KC 710/20	KC 720/20
7	21	KC 710/21	
7 ¹ / ₃	22	KC 710/22	KC 720/22
7 ² / ₃	23	KC 710/23	
8	24	KC 710/24	KC 720/24
8 ¹ / ₃	25	KC 710/25	
8 ² / ₃	26	KC 710/26	KC 720/26
9	27	KC 710/27	
9 ¹ / ₃	28	KC 710/28	KC 720/28
9 ² / ₃	29	KC 710/29	
10	30	KC 710/30	KC 720/30
10 ² / ₃	32		KC 720/32
11 ¹ / ₃	34		KC 720/34
12	36		KC 720/36

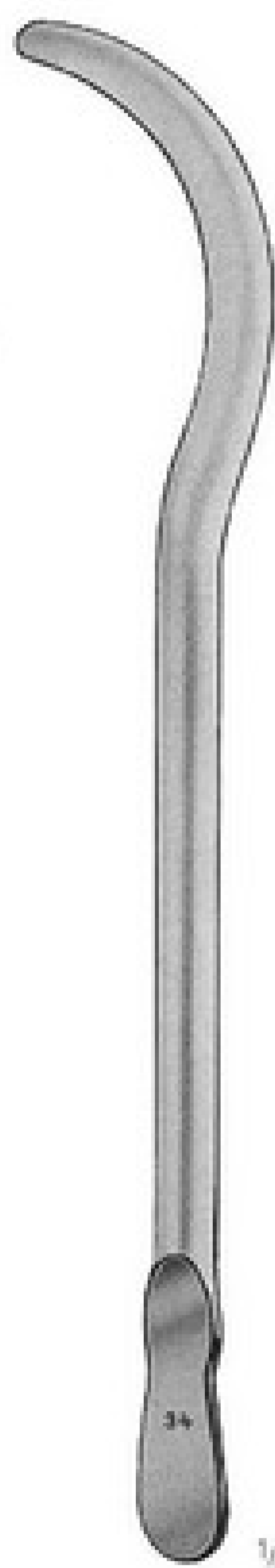

GUYON
 27,0 cm/10¹/₂"

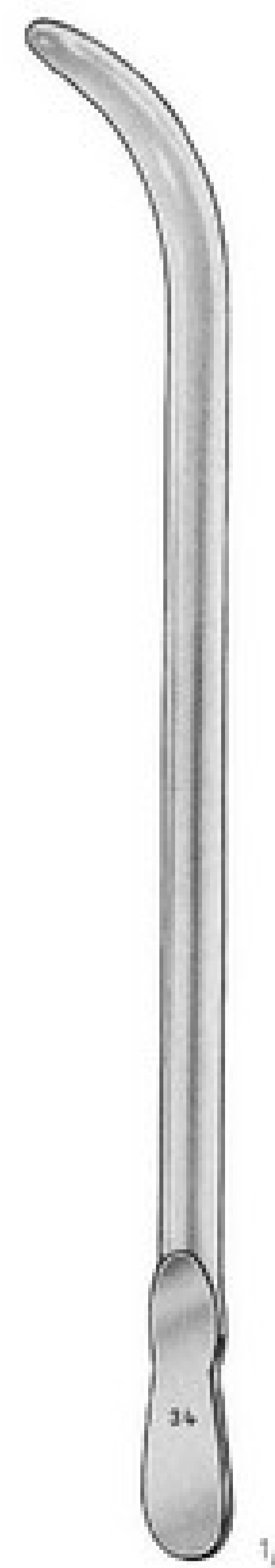

VAN BUREN
 28,0 cm/11"

ohne Gewinde
 without thread
 sin rosca
 sans filet
 senza filetto

Metal-Katheter
 Metal Catheters
 Sondas metálicas
 Sondes métalliques
 Sonda metaliche

für Männer
 Male Catheters
 para hombres
 pour hommes
 per uomini

für Frauen
 Female Catheters
 para mujeres
 pour femmes
 per donne

	mm Ø	
KC 750/06	2	KC 751/06
KC 750/07	2 ¹ / ₃	KC 751/07
KC 750/08	2 ² / ₃	KC 751/08
KC 750/09	3	KC 751/09
KC 750/10	3 ¹ / ₃	KC 751/10
KC 750/11	3 ² / ₃	KC 751/11
KC 750/12	4	KC 751/12
KC 750/13	4 ¹ / ₃	KC 751/13
KC 750/14	4 ² / ₃	KC 751/14
KC 750/15	5	KC 751/15
KC 750/16	5 ¹ / ₃	KC 751/16
KC 750/17	5 ² / ₃	KC 751/17
KC 750/18	6	KC 751/18
KC 750/19	6 ¹ / ₃	KC 751/19
KC 750/20	6 ² / ₃	KC 751/20
KC 750/21	7	KC 751/21
KC 750/22	7 ¹ / ₃	KC 751/22
KC 750/23	7 ² / ₃	KC 751/23
KC 750/24	8	KC 751/24



KC 750/06 -
 KC 750/24
 27,0 cm/10¹/₂"

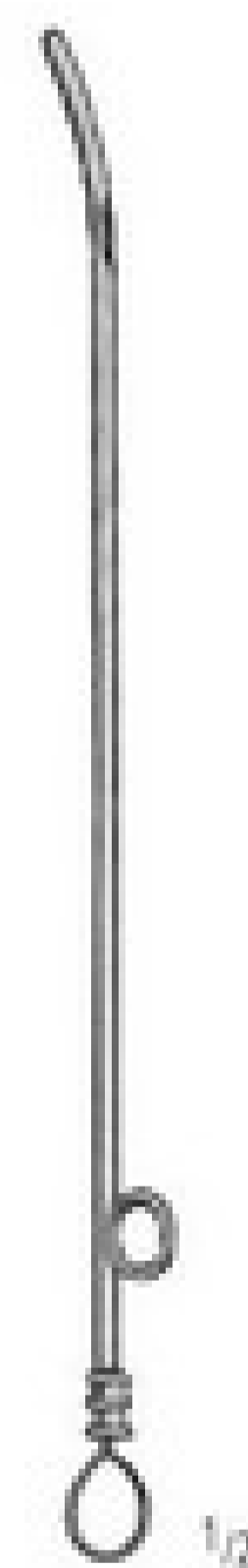

KC 751/06 -
 KC 751/24
 15,0 cm/6"