

**KD** MASTDARM RECTUM RECTO RECTUM RETTO

Mastdarm - Spekula  
 Rectal Specula  
 Espécules rectales  
 Spéculum rectaux  
 Specoli rettali

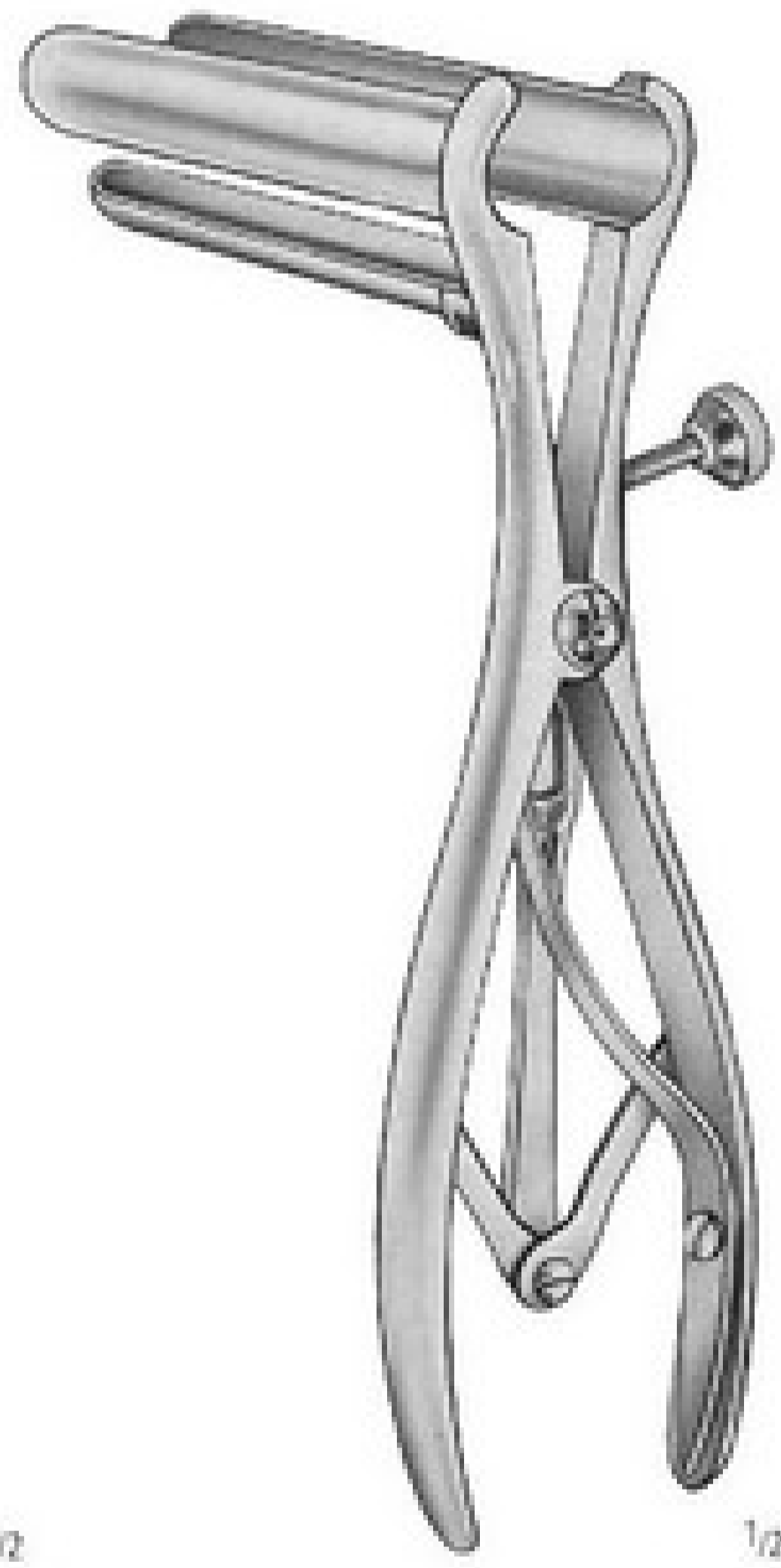

**PRATT**  
 KD 640/21  
 21,5 cm/8½"  
 85 x 25 mm



**MATHIEU**  
 KD 650/19  
 19,5 cm/7¾"  
 90 x 15 mm



**SMITH-BUIE**  
 KD 660/15  
 15,0 cm/6"  
 75 x 23 mm

MASTDARM RECTUM RECTO RECTUM RETTO

Sphinkteroskope, Anuskope, Proktoskope  
 Sphincteroscopes, Anoscopes, Proctoscopes  
 Esfinteroscopios, Anoscopios, Proctoscopios  
 Sphinctérosopes, Anoscopes, Proctoscopes  
 Sfinteroscopi, Anoscopi, Proctoscopi

KA

KB

KC

**KD**

KK

KL

KM

KO

KP

KU



**ROSCHKE**  
 KD 662/01  
 1/2 Ø 15/30 x 70 mm



**ROSCHKE**  
 KD 662/02  
 1/2 Ø 15/30 x 70 mm



**ALAN PARKS**  
 KD 665/01

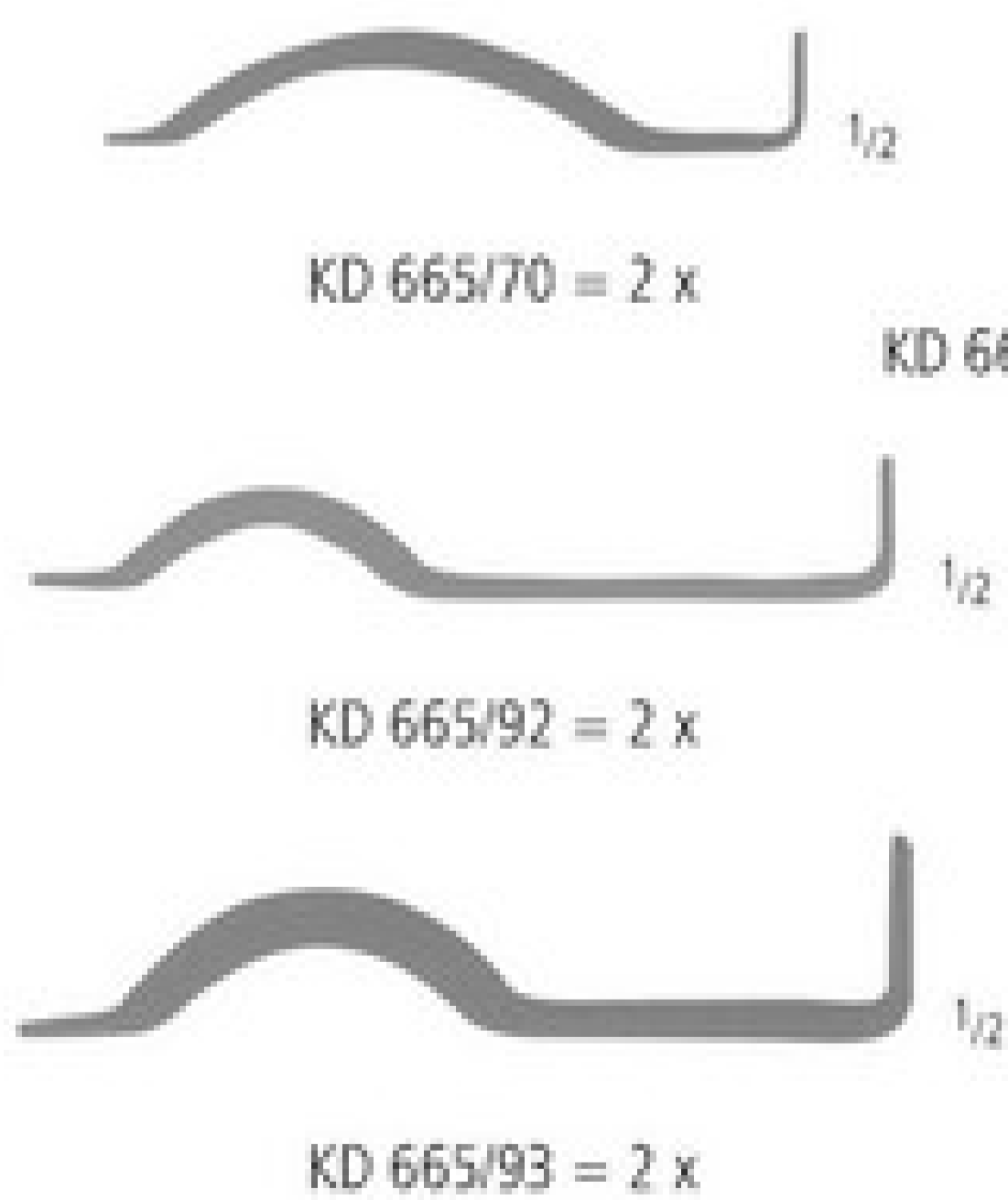

komplett mit 2 Paar Blätter  
 Complete with 2 pair of blades

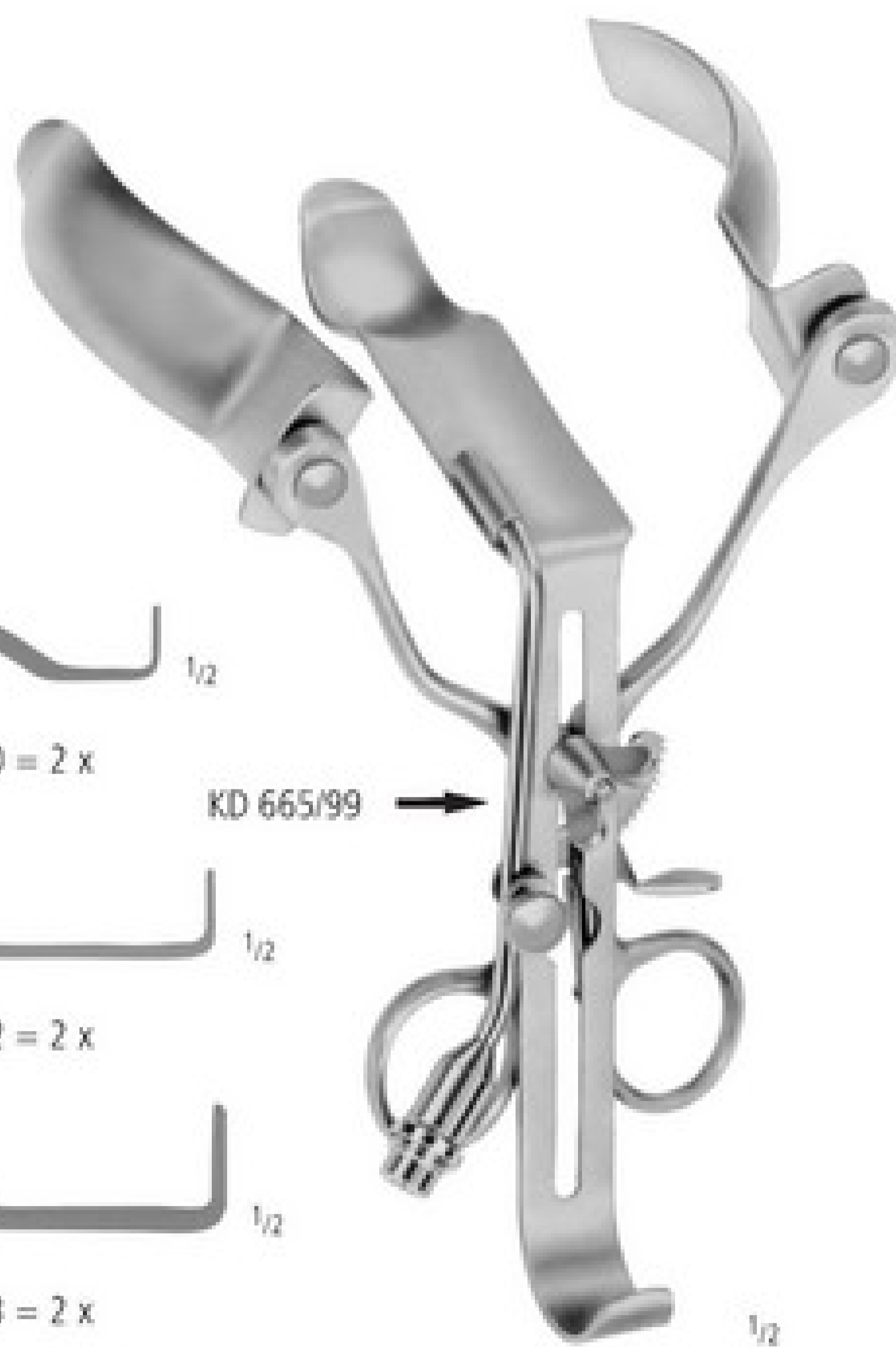

**ALAN PARKS**  
 KD 665/02

**KD** MASTDARM RECTUM RECTO RECTUM RETTO

Sphinkteroskope, Anuskope, Proktoskope  
 Sphincteroscopes, Anoscopes, Proctoscopes  
 Esfinteroscopios, Anoscopios, Proctoscopios  
 Sphinctéroscoptes, Anuscopes, Proctoscopes  
 Sfinteroscopi, Anoscopi, Proctoscopi



**IVES-FANSLER**  
 KD 668/22  
 Ø 22 mm



**IVES-FANSLER**  
 KD 669/22  
 Ø 22 mm

KD 669/99

MASTDARM RECTUM RECTO RECTUM RETTO

Sphinkterskope, Anuskope, Proktoskope  
 Sphincteroscopes, Anoscopes, Proctoscopes  
 Esfinteroscopios, Anoscopios, Proctoscopios  
 Sphinctérosopes, Anoscopes, Proctoscopes  
 Sfinteroscopi, Anoscopi, Proctoscopi

KA

KB

KC

**KD**

KK

KL

KM

KO

KP

KU



**HIRSCHMANN**

- KD 670/01 = 16 mm Ø x 65 mm
- KD 670/02 = 19 mm Ø x 65 mm
- KD 670/03 = 22 mm Ø x 65 mm
- KD 670/04 = 22 mm Ø x 125 mm

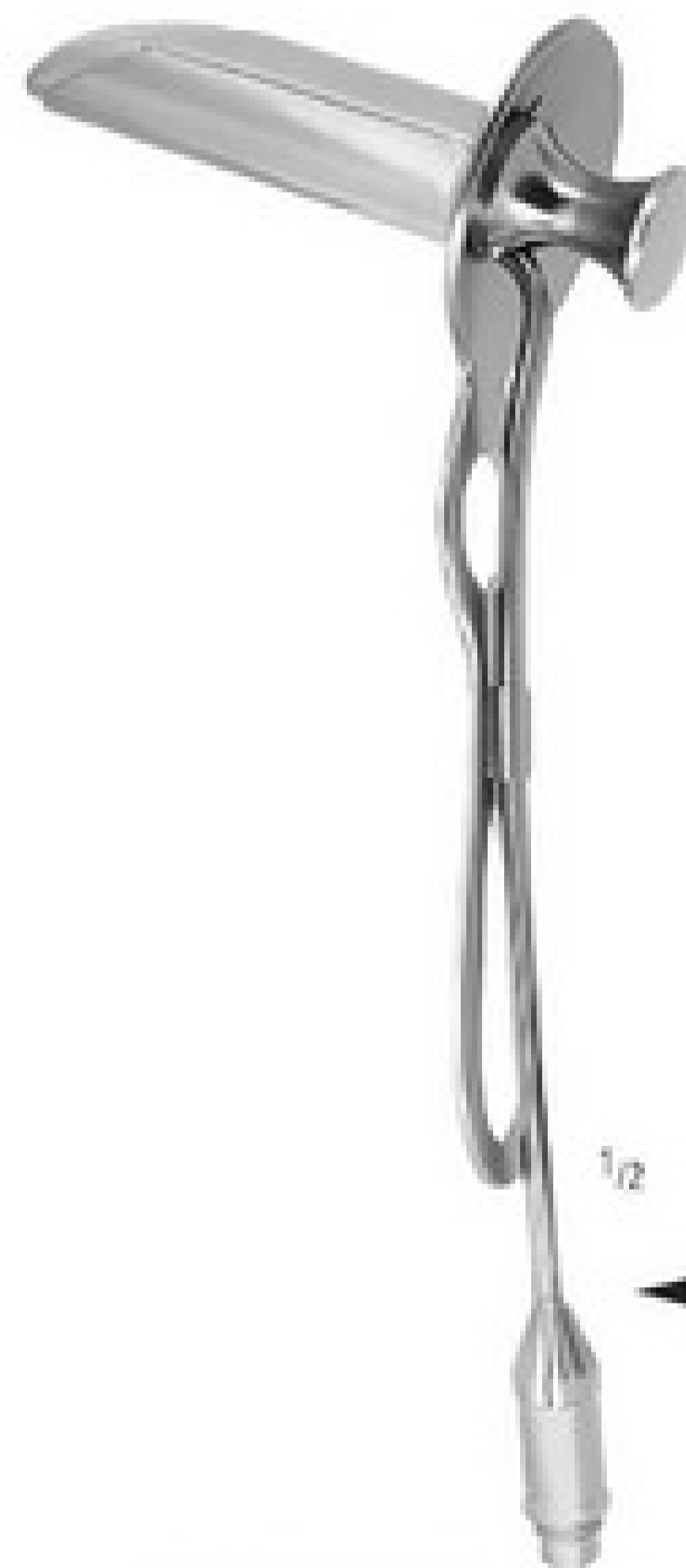

**HIRSCHMANN**

- KD 671/01 = 16 mm Ø x 60 mm
- KD 671/02 = 19 mm Ø x 70 mm
- KD 671/03 = 24 mm Ø x 90 mm
- KD 671/04 = 24 mm Ø x 130 mm

**KD** MASTDARM RECTUM RECTO RECTUM RETTO

Sphinkteroskope, Anuskope, Proktoskope  
 Sphincteroscopes, Anoscopes, Proctoscopes  
 Esfinteroscopios, Anoscopios, Proctoscopios  
 Sphinctérosopes, Anusopes, Proctosopes  
 Sfinteroscopi, Anoscopi, Proctoscopi



1/2

**BENSAUDE**

KD 675/19 = 19 mm Ø x 70 mm

KD 675/22 = 22 mm Ø x 70 mm

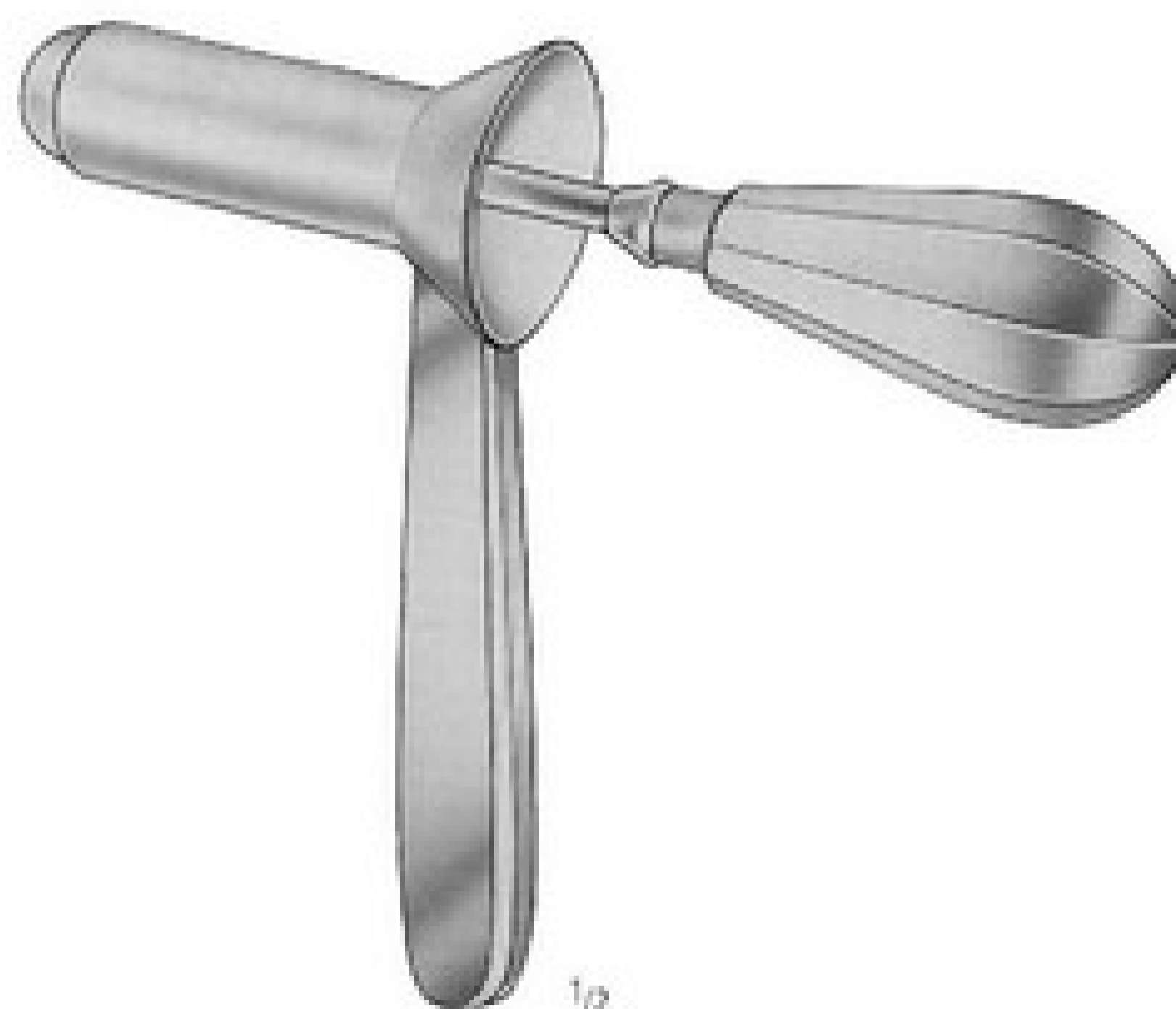

1/2

**KELLY**

KD 680/05 = 22 mm Ø x 50 mm

KD 680/10 = 22 mm Ø x 100 mm

KD 680/14 = 22 mm Ø x 140 mm

KD 680/20 = 22 mm Ø x 200 mm

MASTDARM RECTUM RECTO RECTUM RETTO

Sphinkteroskope, Anuskope, Proktoskope  
 Sphincteroscopes, Anoscopes, Proctoscopes  
 Esfinteroscopios, Anoscopios, Proctoscopios  
 Sphinctérosopes, Anoscopes, Proctoscopes  
 Sfinteroscopi, Anoscopi, Proctoscopi

KA

KB

KC

**KD**

KK

KL

KM

KO

KP

KU



**KELLY**

KD 685/21 = 21 mm Ø x 50 mm

KD 685/27 = 27 mm Ø x 50 mm



**MORGAN**

KD 690/01 = 17 mm Ø x 65 mm

KD 690/02 = 17 mm Ø x 80 mm

KD 690/03 = 20 mm Ø x 65 mm

KD 690/04 = 20 mm Ø x 80 mm

KD 690/05 = 24 mm Ø x 65 mm

KD 690/06 = 24 mm Ø x 80 mm

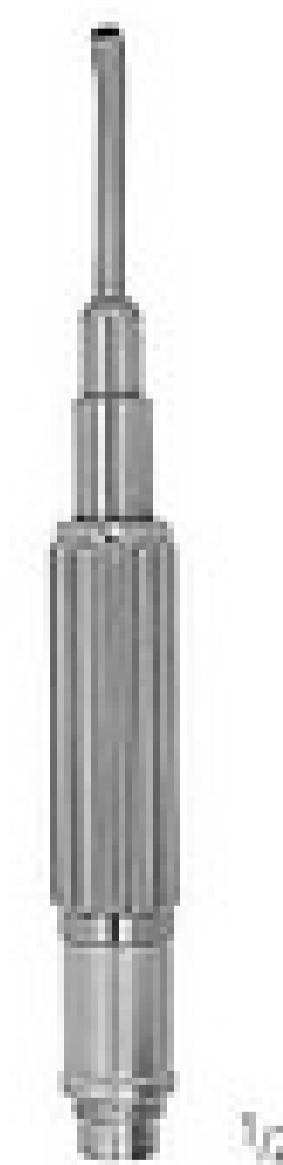

**MORGAN**

KD 690/99

**KALTLICHT / FIBRE OPTIC**

**KD** MASTDARM RECTUM RECTO RECTUM RETTO

Anuskope, Proktoskope  
 Anoscopes, Proctoscopes  
 Anoscopios, Proctoscopios  
 Anuscopes, Proctoscopes  
 Anoscopi, Proctoscopi

**BLOND**

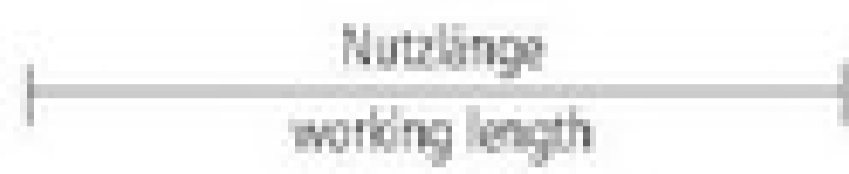

KD 700/01  
 18/24 mm Ø x 75 mm

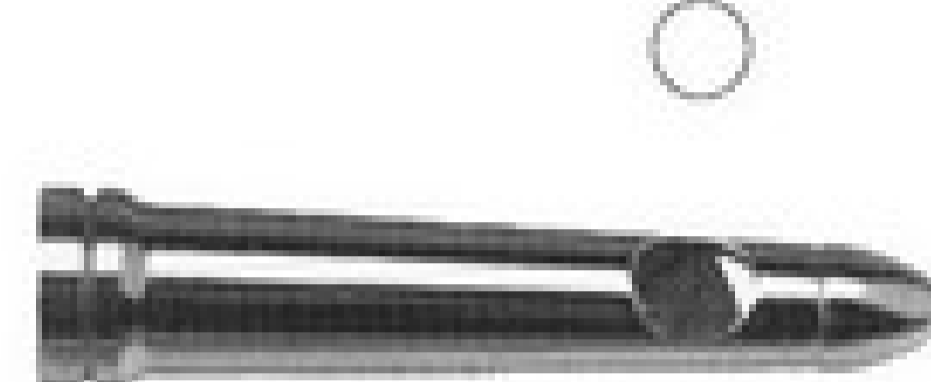

KD 700/02  
 18/24 mm Ø x 75 mm



KD 700/03  
 15/23 mm Ø x 75 mm



KD 700/04  
 18/25 mm Ø x 105 mm

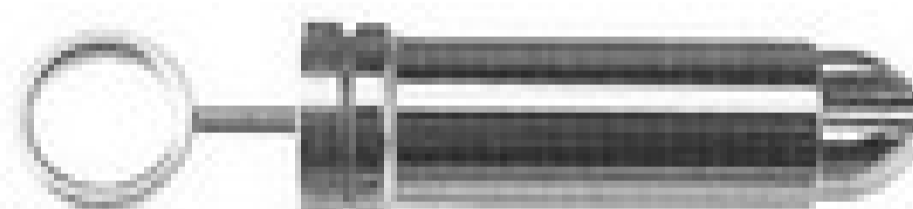

KD 702/01  
 26 mm Ø x 60 mm



KD 702/02  
 21 mm Ø x 80 mm



KD 702/03  
 24 mm Ø x 80 mm



KD 702/04  
 21 mm Ø x 120 mm

MASTDARM RECTUM RECTO RECTUM RETTO

Anuskope, Proktoskope  
 Anoscopes, Proctoscopes  
 Anoscopios, Proctoscopios  
 Anuscopes, Proctoscopes  
 Anoscopi, Proctoscopi

KA

KB

KC

**KD**

KK

KL

KM

KO

KP

KU

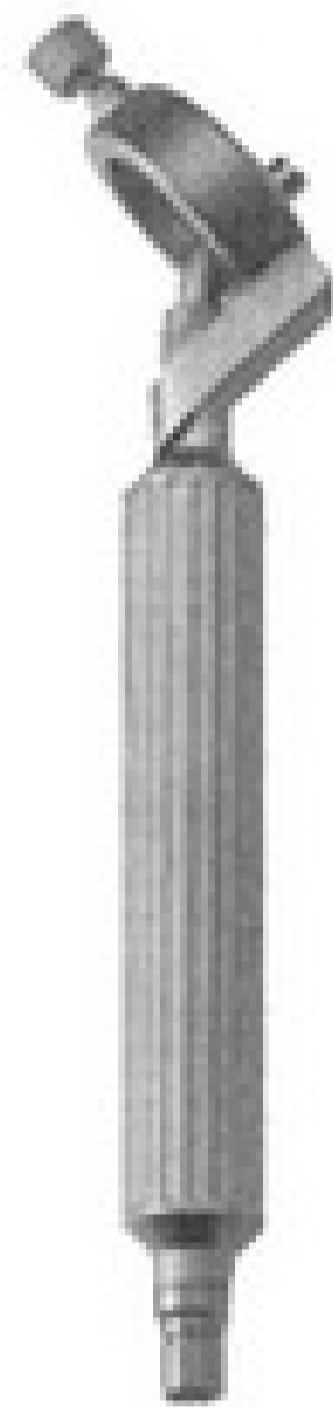

KD 705/01



KD 705/02 = KD 705/80  
 KD 705/90  
 KD 705/99

← KD 705/90

← KD 705/80



KD 705/99  
 2,5 V

GRIFFE FÜR KD 700/01 - KD 702/04  
 HANDLES FOR KD 700/01 - KD 702/04



**BLOND**  
 KD 707/01 = KD 705/01  
 KD 700/01



**BLOND**  
 KD 707/02 = KD 705/02  
 KD 700/01



Rektoskope  
 Rectoscopes  
 Rectoscopios  
 Rektoskopes  
 Rectoscopi



**KALTLICHT KOPF**  
**F/O HEAD**  
 KD 715/01

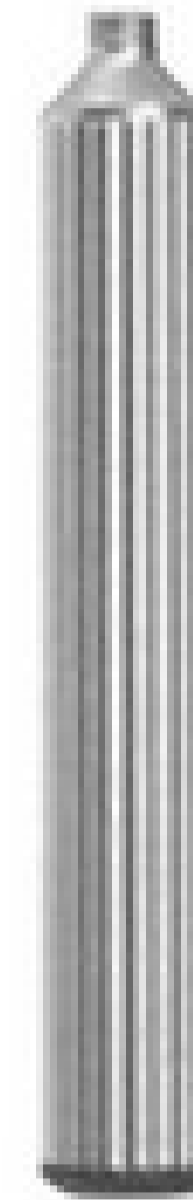

**KALTLICHT**  
**FIBRE OPTIC**  
 KD 715/02

**GRIFFE FÜR NACHFOLGENDE TUBEN**  
**HANDLES FOR TUBES SHOWN NEXT PAGES**



**KD 717/01**  
**KOPF für**            **KD 717/02**  
**HEAD for**         **KD 717/02**

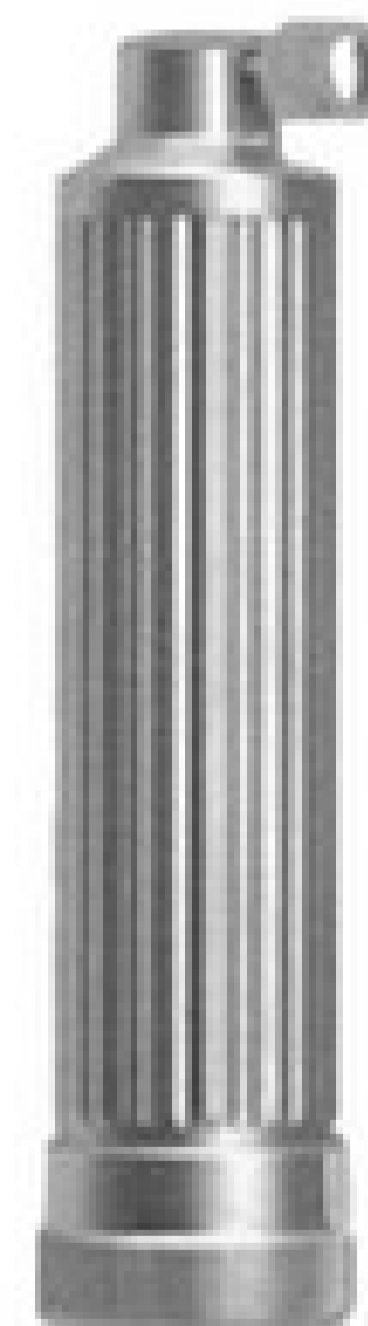

**WARMLICHT**  
**BATTERY**  
 KD 717/02

MASTDARM RECTUM RECTO RECTUM RETTO

Rektoskope  
 Rectoscopes  
 Rectoscopios  
 Rektoskopes  
 Rectoscopi

KA

KB

KC

**KD**

KK

KL

KM

KO

KP

KU

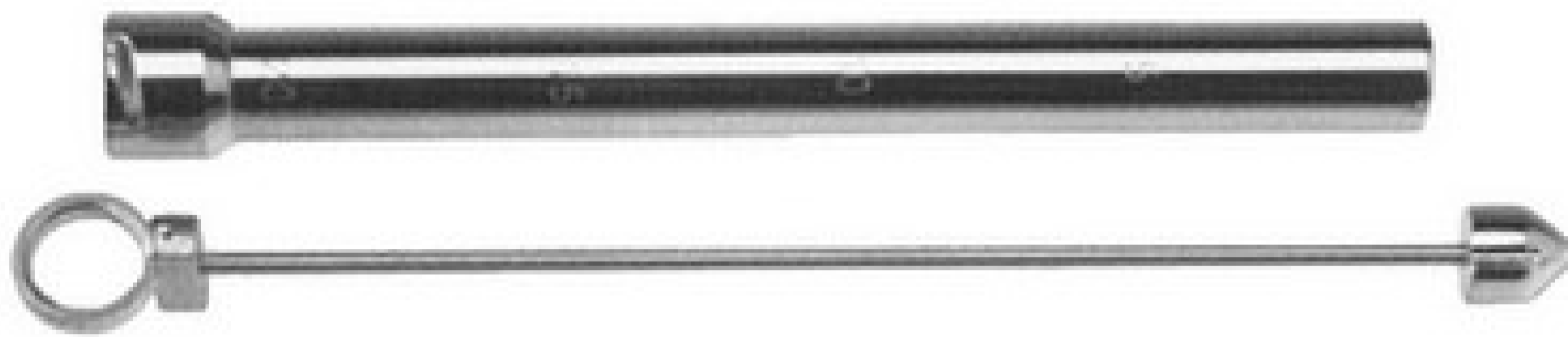

**DIAGNOSTIC**  
 KD 719/15 = 15 mm Ø x 200 mm

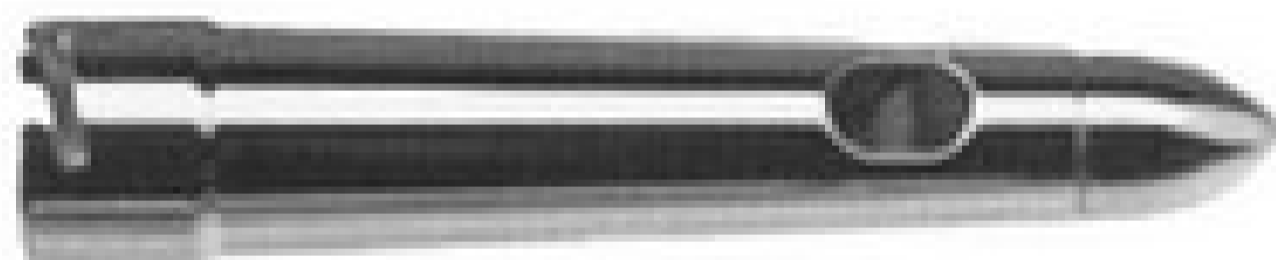

**PROKTOSKOP**  
 KD 720/00 = 18/24 mm Ø x 75 mm

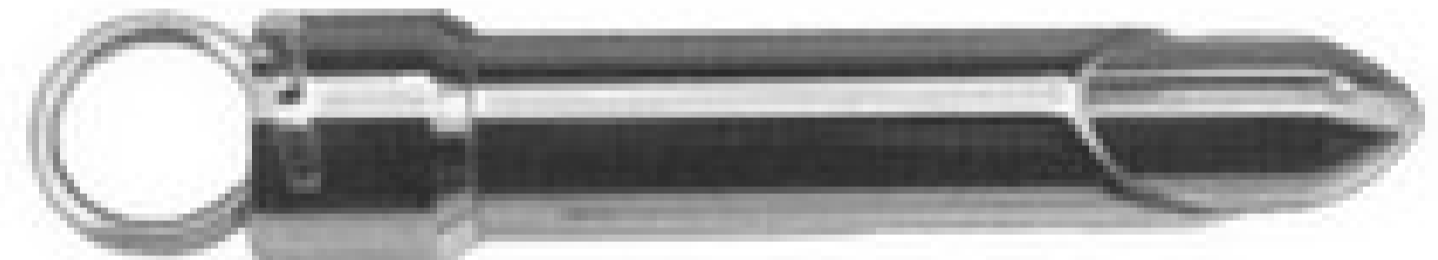

**ANUSKOP**  
 KD 722/00 = 21 mm Ø x 80 mm



**KALTLICHT / FIBRE OPTIC**  
 KD 722/99  
 75 mm

**KD** MASTDARM RECTUM RECTO RECTUM RETTO

Rektoskope  
Rectoscopes  
Rectoscopios  
Rektoskopes  
Rectoscopi

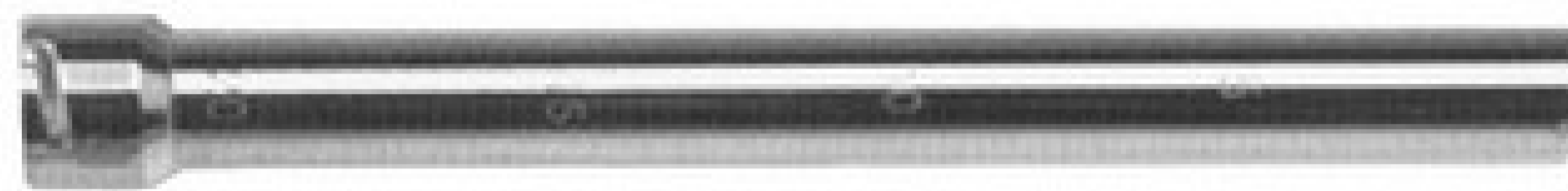

KD 724/20 = 20 mm Ø x 200 mm  
KD 724/25 = 20 mm Ø x 250 mm  
KD 724/30 = 20 mm Ø x 300 mm

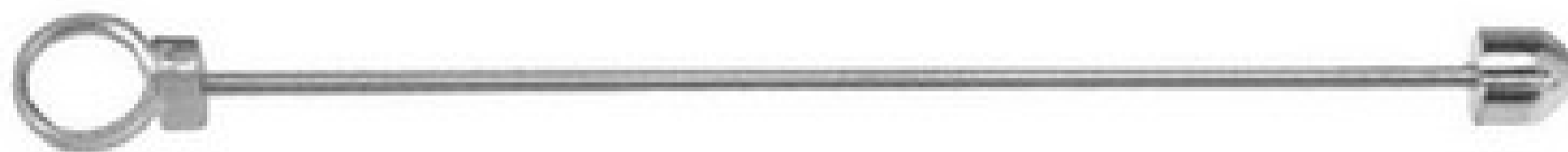

KD 725/20 = 200 mm  
KD 725/25 = 250 mm  
KD 725/30 = 300 mm



**KALTLICHT  
FIBRE OPTIC**

KD 728/20 = 200 mm  
KD 728/25 = 250 mm  
KD 728/30 = 300 mm

**WARMLICHT  
CONVENTIONAL ILLUMINATION**

KD 729/20 = 200 mm  
KD 729/25 = 250 mm  
KD 729/30 = 300 mm

KD 729/99



**VERSCHLUSSDECKEL  
COVER CAP**  
KD 731/00



**SCHWENKLUPE  
SWIVEL LENS**  
KD 731/01

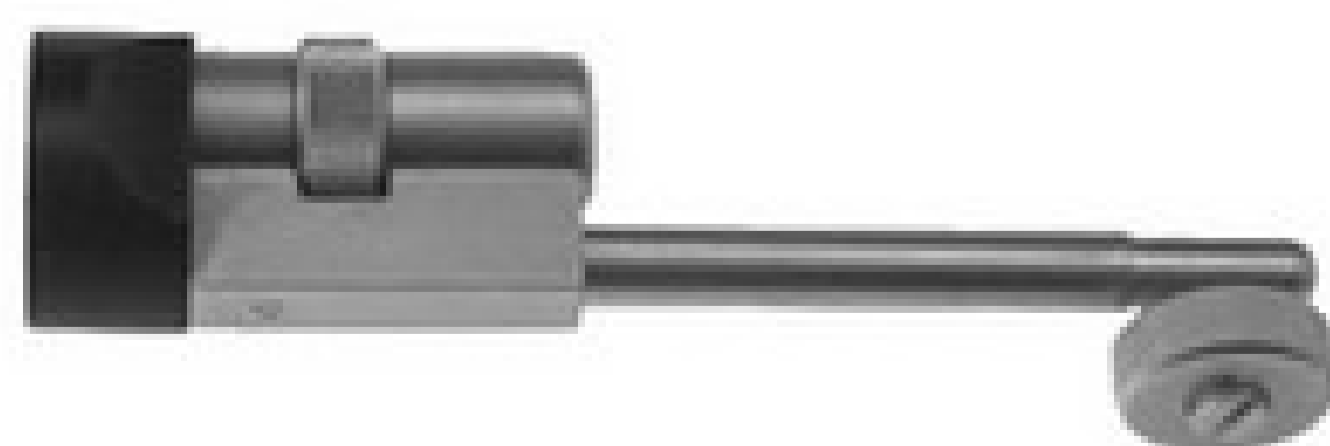

**TELESKOPOPTIK  
TELESCOPE**  
KD 731/02



**DOPPELGEBLÄSE MIT L/L  
DOUBLEBLOWER WITH L/L**  
KD 731/04

Rektoskope  
 Rectoscopes  
 Rectoscopios  
 Rektoskopes  
 Rectoscopi

KA

KB

KC

KD

KE

KL

KM

KN

KO

KP

KQ

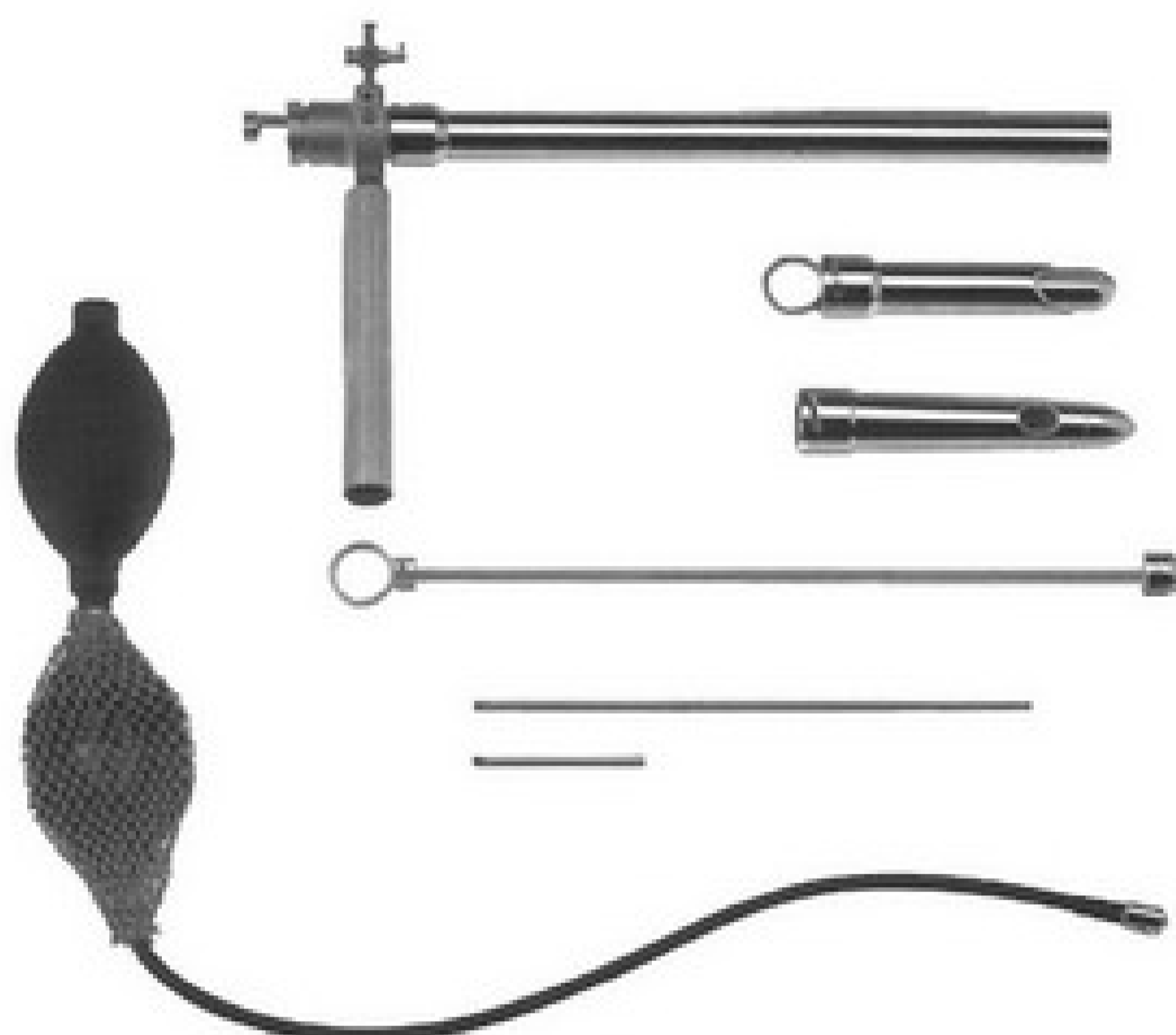

KD 740/00 = KD 715/01  
 KD 731/00  
 KD 731/01  
 KD 715/02  
 KD 724/25  
 KD 725/25  
 KD 728/25  
 KD 720/00  
 KD 722/00  
 KD 722/99  
 KD 731/04

#### REKTO - PROKTOSKOPSET MIT F/O - BELEUCHTUNG

F/O - Rektoskopkopf mit Zweiweghahn, Verschlussdeckel und Schwenklupe, Griff, Rektoskoptubus 250 mm, Ø 20 mm mit Mandrin und F/O Lichtträger, Anuskoptubus 80 mm, mit Mandrin, Proktoskoptubus mit Seitenfenster und kurzem F/O Lichtträger, Doppelgebläse.

#### RECTO - PROCTOSCOPE WITH F/O - ILLUMINATION

F/O - Rectoscope-head with two-way stop-cock, lens cover and swivel lens, handle, Rectoscope-tube 250 mm, Ø 20 mm, with obturator and F/O light-carrier, Anoscope-tube 80 mm with obturator, Proctoscope-tube with lateral window and short F/O light-carrier, double blower.

Rektoskope  
 Rectoscopes  
 Rectoscopios  
 Rektoskopes  
 Rectoscopi

**STRAUSS**

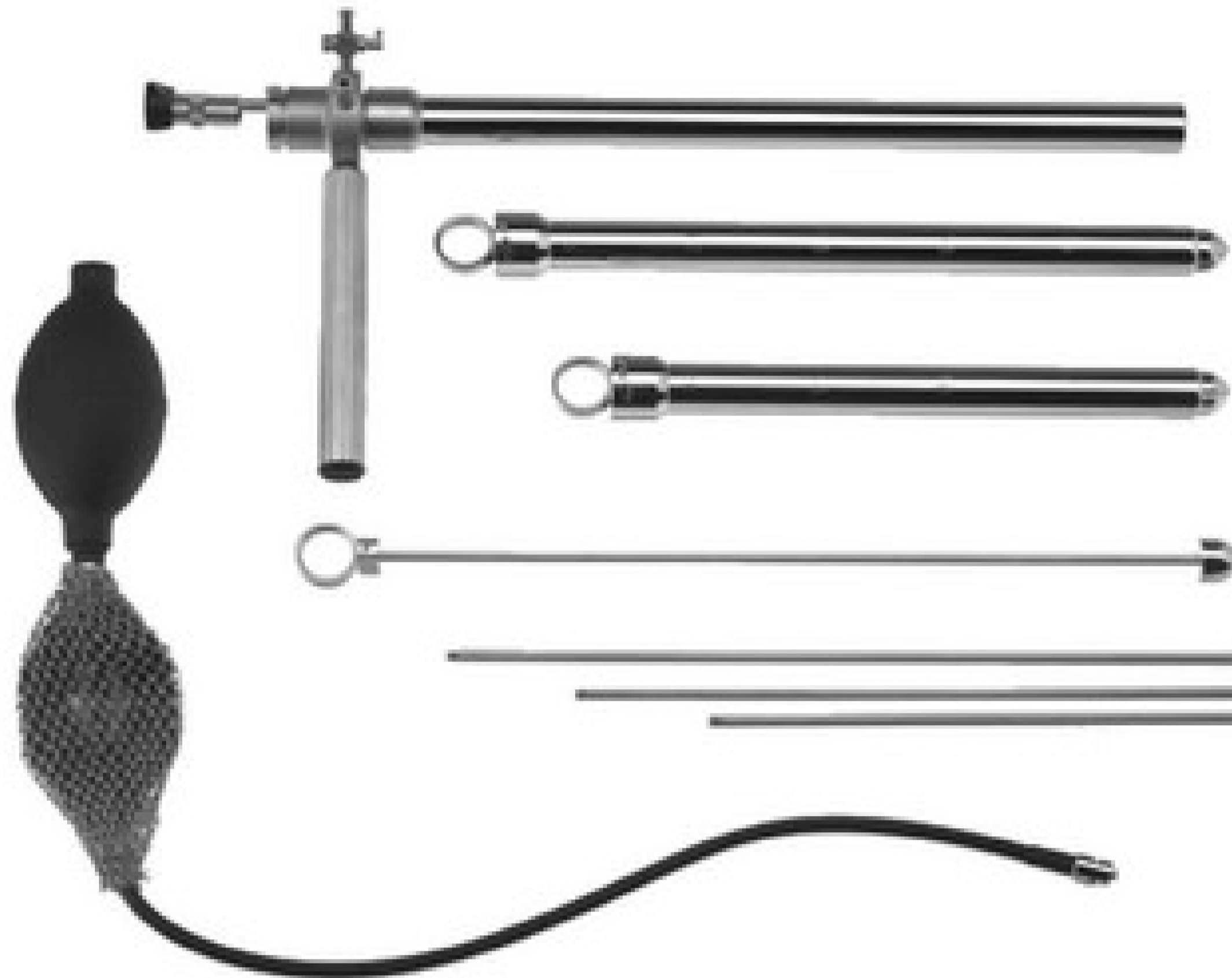

- KD 741/00 = KD 715/01
- KD 715/02
- KD 731/00
- KD 731/02
- KD 724/20
- KD 724/25
- KD 724/30
- KD 725/20
- KD 725/25
- KD 725/30
- KD 728/20
- KD 728/25
- KD 728/30
- KD 731/04

**F/O - REKTOSKOP NACH STRAUSS**

F/O - Rektoskopkopf mit Zweiweghahn, Verschlussdeckel und Teleskop-Optik, Griff, je ein Rektoskoptubus in 200 mm 250 mm und 300 mm, Ø 20 mm, mit Mandrin und F/O Lichtträger, Doppelgebläse.

**F/O - RECTOSCOPE BY STRAUSS**

F/O - Rectoscope-head with two-way stop-cock, lens cover and telescope, handle, 3 Rectoscope-tubes Ø 20 mm, with obturator and F/O light-carrier 200 mm, 250 mm and 300 mm, double blower.

Rektoskope  
 Rectoscopes  
 Rectoscopios  
 Rektoskopes  
 Rectoscopi

KA

KB

KC

KD

KE

KF

KG

KH

KI

KJ

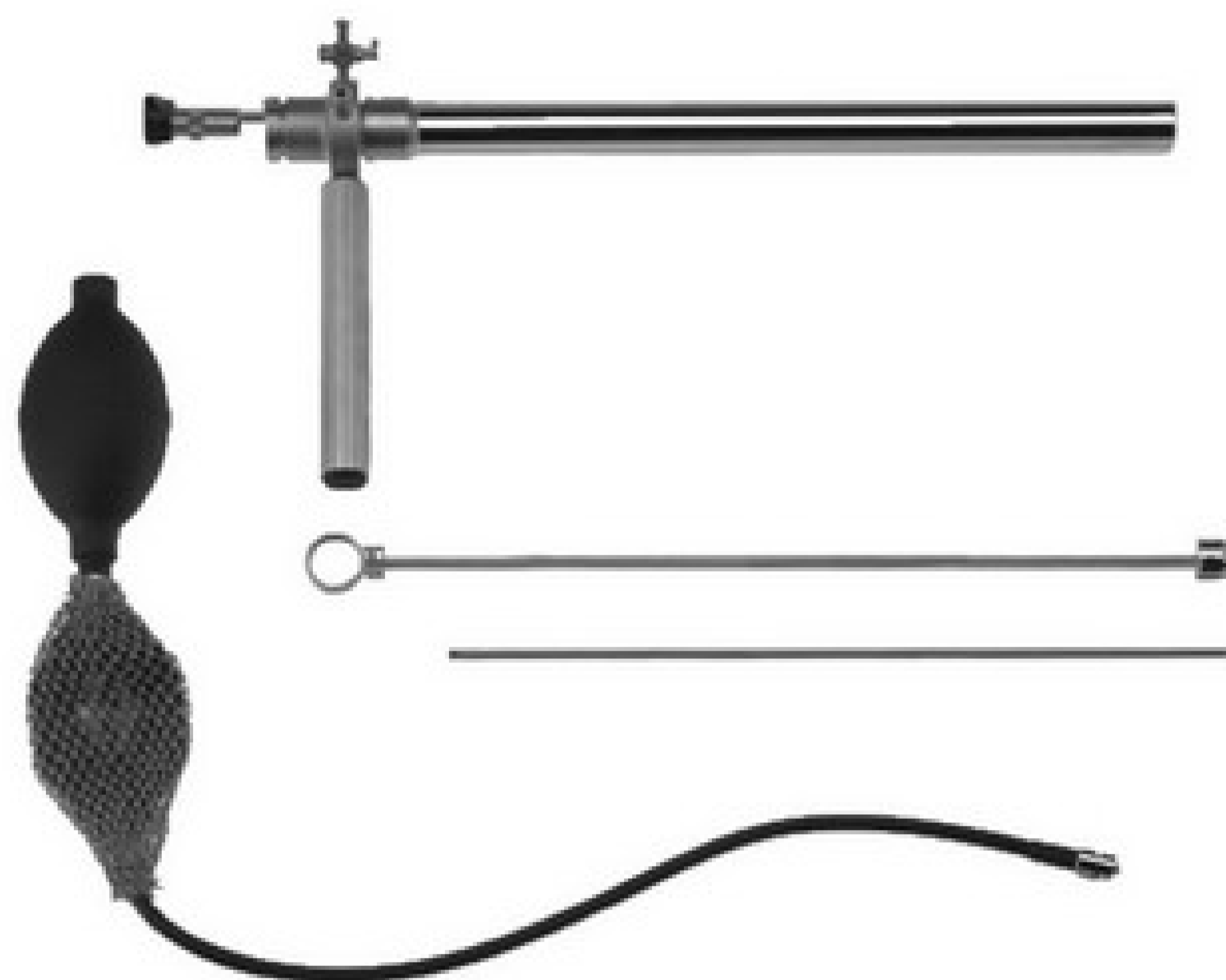

KD 742/00 = KD 715/01  
 KD 731/00  
 KD 731/02  
 KD 715/02  
 KD 724/30  
 KD 725/30  
 KD 728/30  
 KD 731/04

#### KOMPLETTES REKTOSKOPSET MIT F/O - BELEUCHTUNG

F/O - Rektoskopkopf mit Zweiweghahn, Verschlussdeckel und Teleskop-Optik, Griff, Rektoskoptubus in 300 mm Ø 20 mm, mit Mandrin und F/O Lichtträger, Doppelgebläse.

#### COMPLETE RECTOSCOPE WITH F/O - ILLUMINATION

F/O - Rectoscope-head with two-way stop-cock, lens cover and telescope, handle, Rectoscope-tube 300 mm, Ø 20 mm, with obturator and F/O light-carrier, double blower.

Rektoskope  
 Rectoscopes  
 Rectoscopios  
 Rektoskopes  
 Rectoscopi

**REKTOSKOP MIT KONVENTIONELLER BELEUCHTUNG  
 RECTOSCOPE WITH CONVENTIONAL ILLUMINATION**



- KD 743/00 = KD 717/01
- KD 731/00
- KD 731/02
- KD 724/30
- KD 725/30
- KD 729/30
- KD 731/04
- KD 717/02

**KOMPLETTES REKTOSKOP MIT KONVENTIONELLER BELEUCHTUNG**

Rektoskopkopf mit Zweiweghahn, Verschlussdeckel und Teleskop-Optik, Rektoskoptubus 300 mm, Ø 20 mm, mit Mandrin und Lampenträger, Doppelgebläse, Batteriegriff.

**COMPLETE RECTOSCOPE WITH CONVENTIONAL ILLUMINATION**

Rectoscope-head with two-way stop-cock, lens cover and telescope, Rectoscope-tube 300 mm, Ø 20 mm, with obturator and lamp-carrier, double blower, battery handle..

MASTDARM RECTUM RECTO RECTUM RETTO

Mastdarm - Biopsiezangen  
 Rectal Biopsy Forceps  
 Pinzas saca bocado para biopsia retal  
 Pinces emporte-pièces à biopsie rectale  
 Pinze tagliente per biopsia rettale

KA

KB

KC

KD

KK

KL

KM

KO

KP

KU

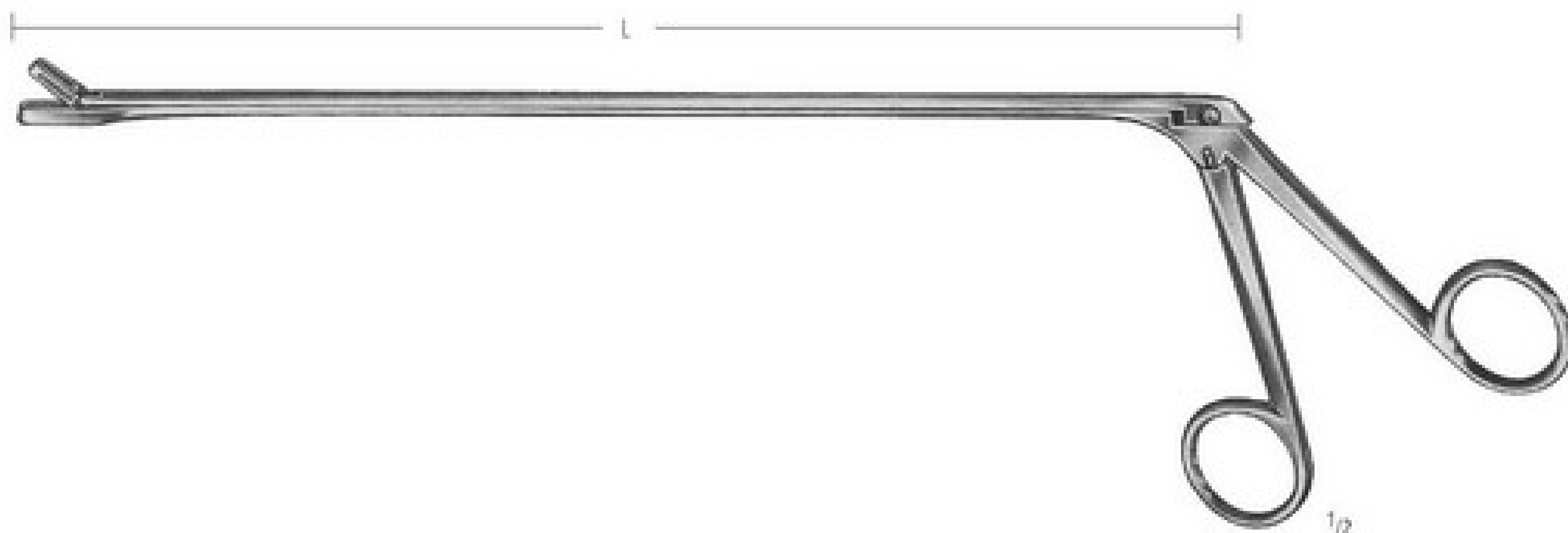

YEOMANN

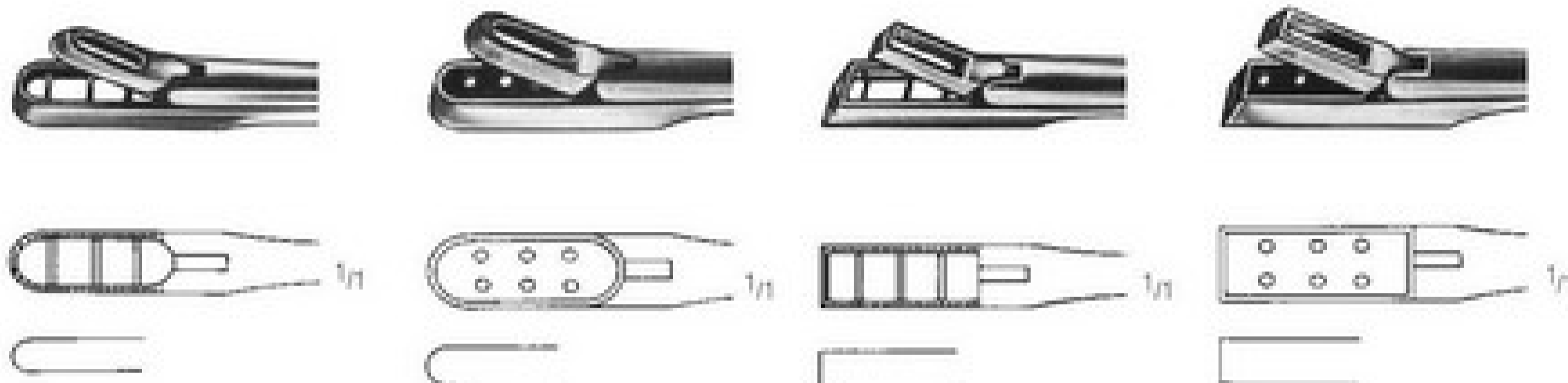

L = 28,0 cm/11"  
 L = 35,0 cm/13<sup>3</sup>/<sub>4</sub>"  
 L = 42,0 cm/16<sup>1</sup>/<sub>2</sub>"

Fig. 1  
 KD 751/28  
 KD 751/35  
 KD 751/42

Fig. 2  
 KD 752/28  
 KD 752/35  
 KD 752/42

Fig. 3  
 KD 753/28  
 KD 753/35  
 KD 753/42

Fig. 4  
 KD 754/28  
 KD 754/35  
 KD 754/42



32,0 cm/13"  
 KX 050/30

45,0 cm/18"  
 KX 050/45



**KD** MASTDARM RECTUM RECTO RECTUM RETTO

Hämorrhoidal-Ligatoren  
 Haemorrhoidal Ligators  
 Ligadores hemorroides  
 Ligateurs hémorroïdes  
 Legatori emorroidali

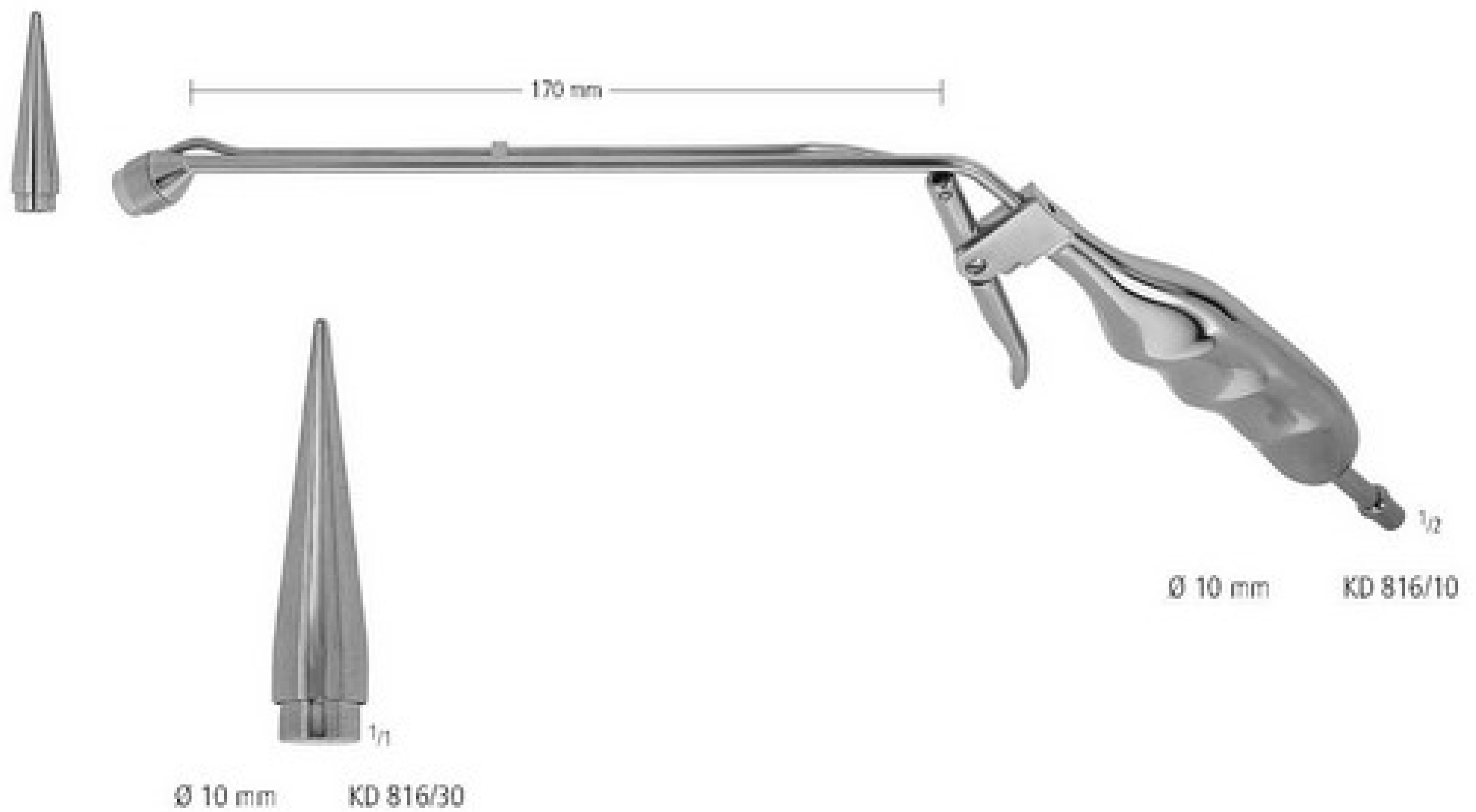
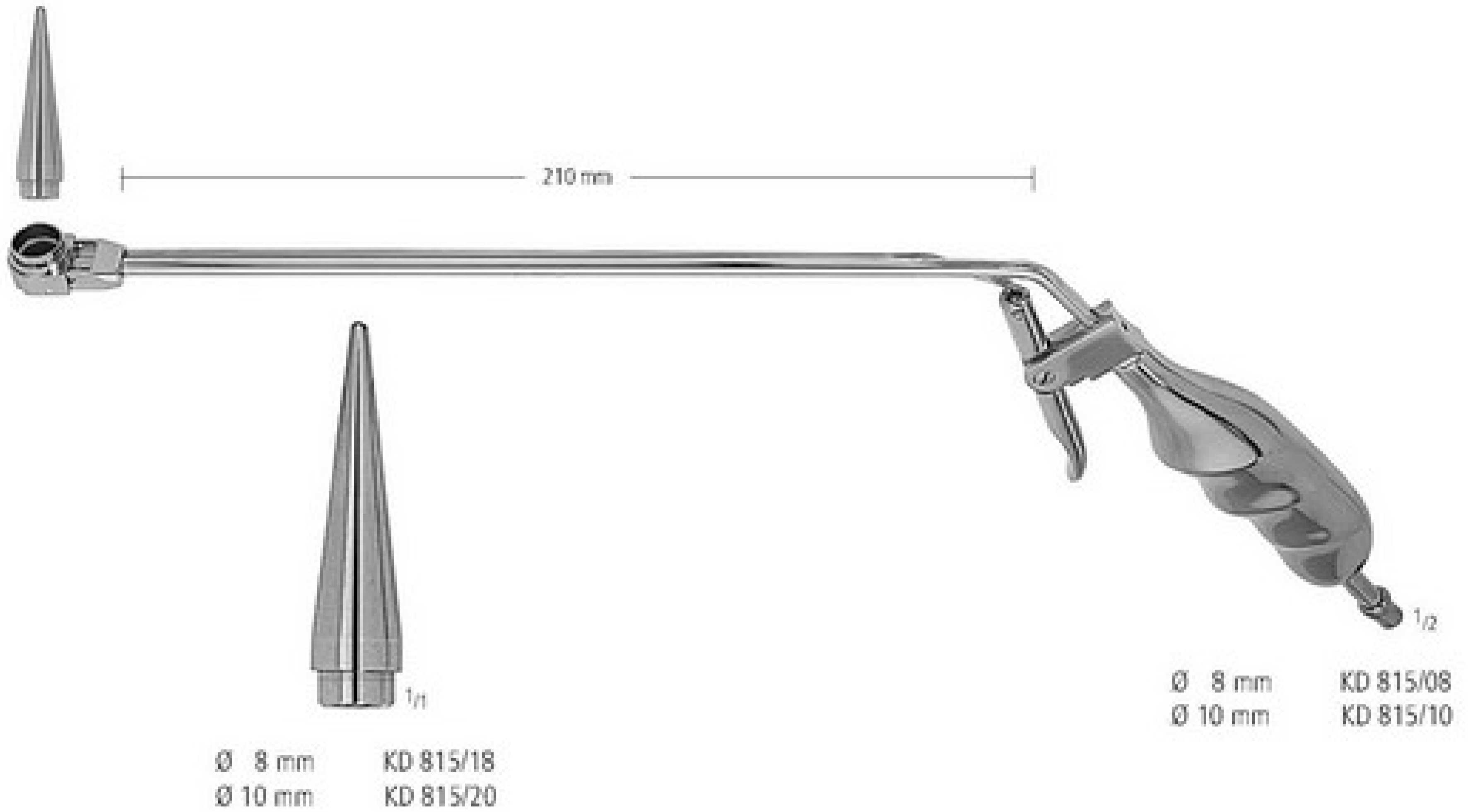

MASTDARM RECTUM RECTO RECTUM RETTO

Hämorrhoidal-Ligatoren  
Haemorrhoidal Ligators  
Ligadores hemorroides  
Ligateurs hémorroïdes  
Legatori emorroidali

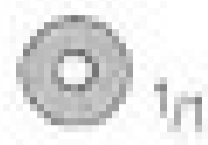

1/11

**KD 817/00**

Ligatur-Gummiringe, 100 Stück  
O-rings, 100 pieces  
Anillos ligadura, 100 piezas  
Anneaux de caoutchouc, 100 pièces  
Anelli per legature, 100 pezzi

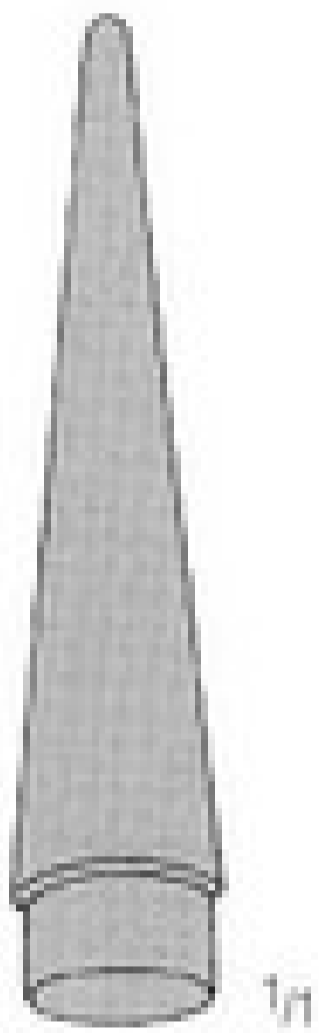

1/11

**KD 818/01**  
Ø 10 mm

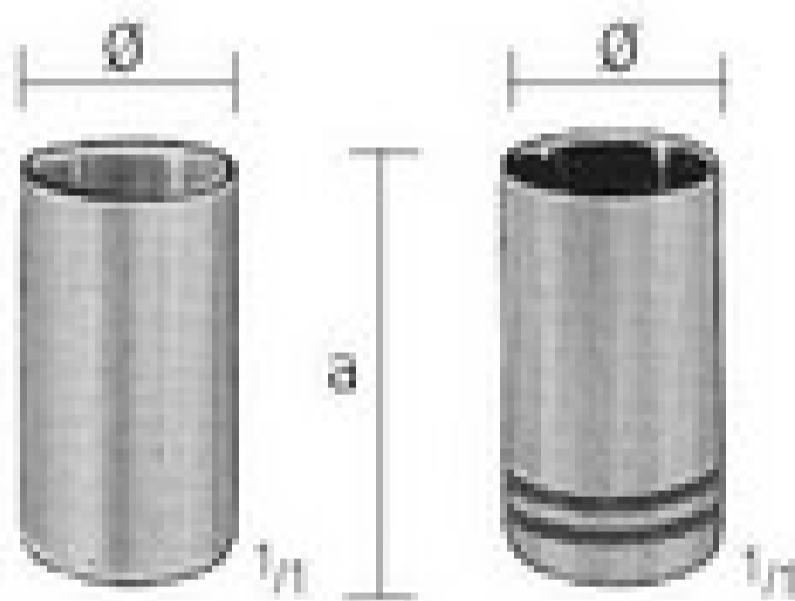

**KD 818/11**  
Ø 10 mm  
a = 11 mm

**KD 818/16**  
Ø 10 mm  
a = 16 mm

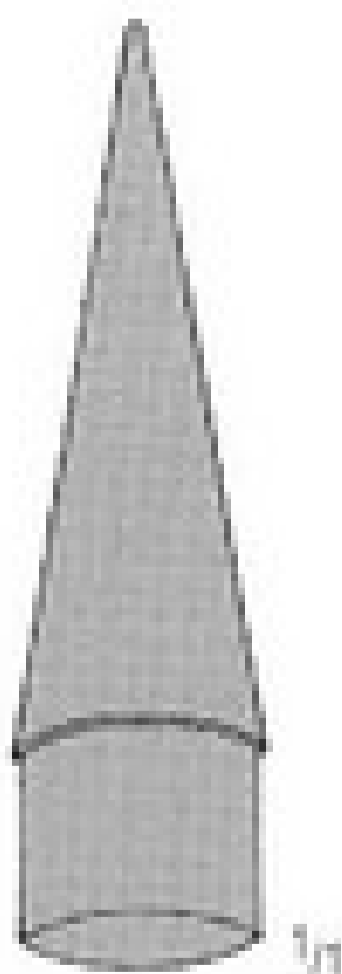

1/11

**KD 820/01**  
Ø 12 mm



**KD 818/00 =**  
mit  
with  
con  
avec  
con  
**KD 818/01 + KD 818/11**

1/2



1/2

**MC GIVNEY**  
**KD 820/19**  
19,0 cm/7 1/2"

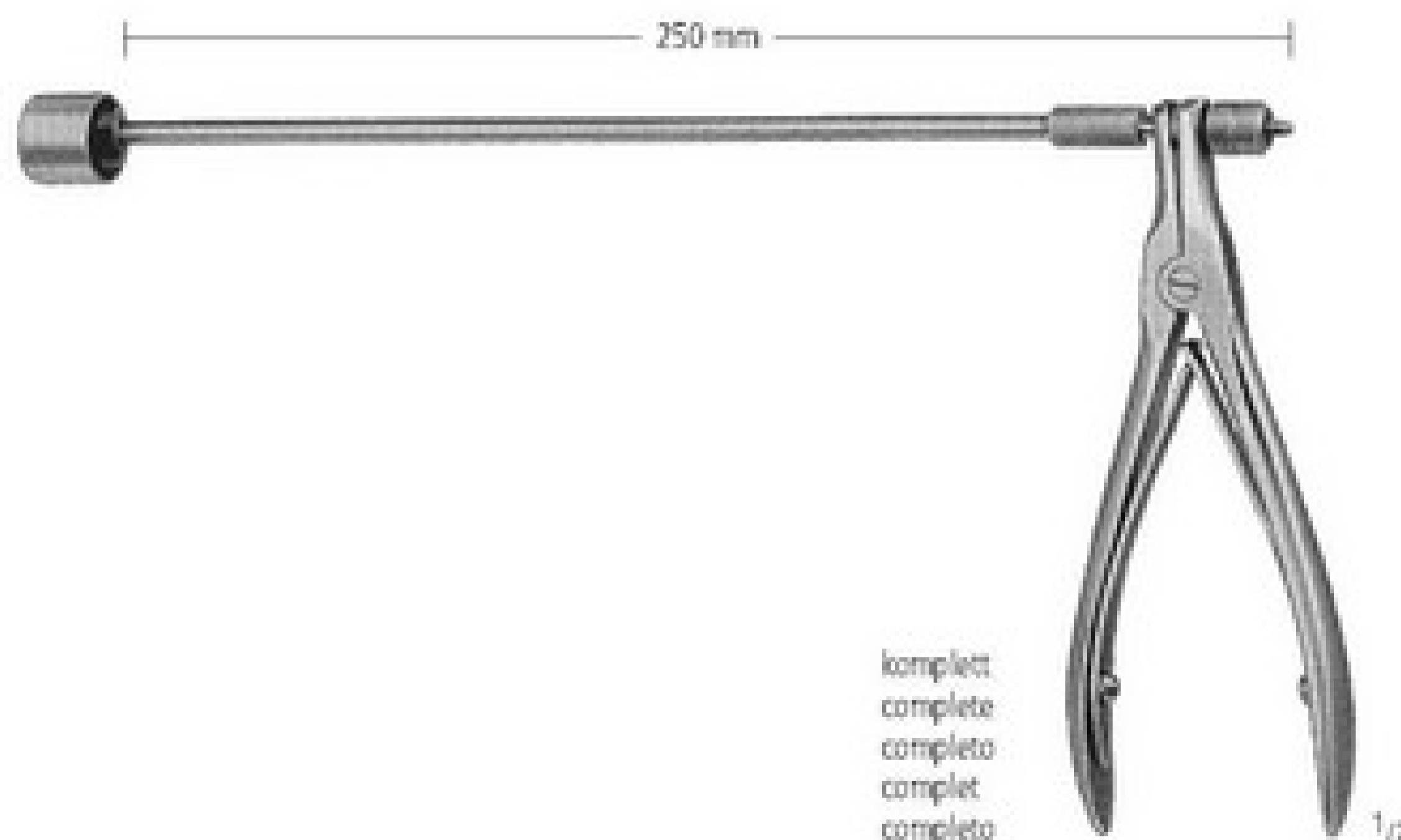

komplett  
complete  
completo  
complet  
completo

1/2

**KD 820/00**

KA

KB

KC

**KD**

KK

KL

KM

KO

KP

KU

**KD** MASTDARM RECTUM RECTO RECTUM RETTO

Hämorrhoidal-Ligatoren  
 Haemorrhoidal Ligators  
 Ligadores hemorroides  
 Ligateurs hémorroïdes  
 Legatori emorroidali



**RUDD**  
 KD 822/00

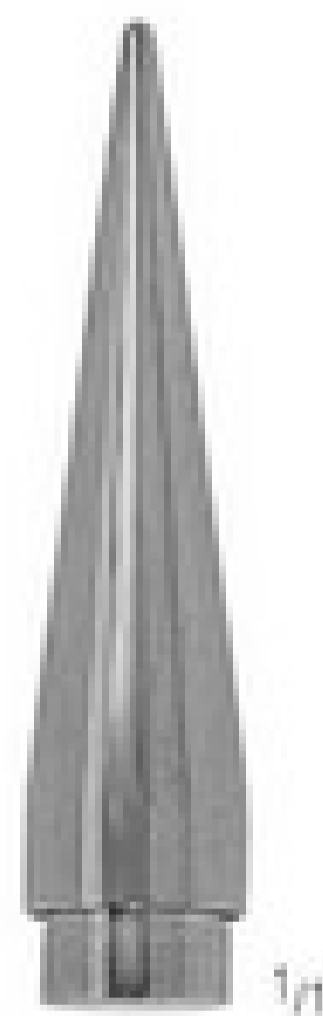

KD 822/12